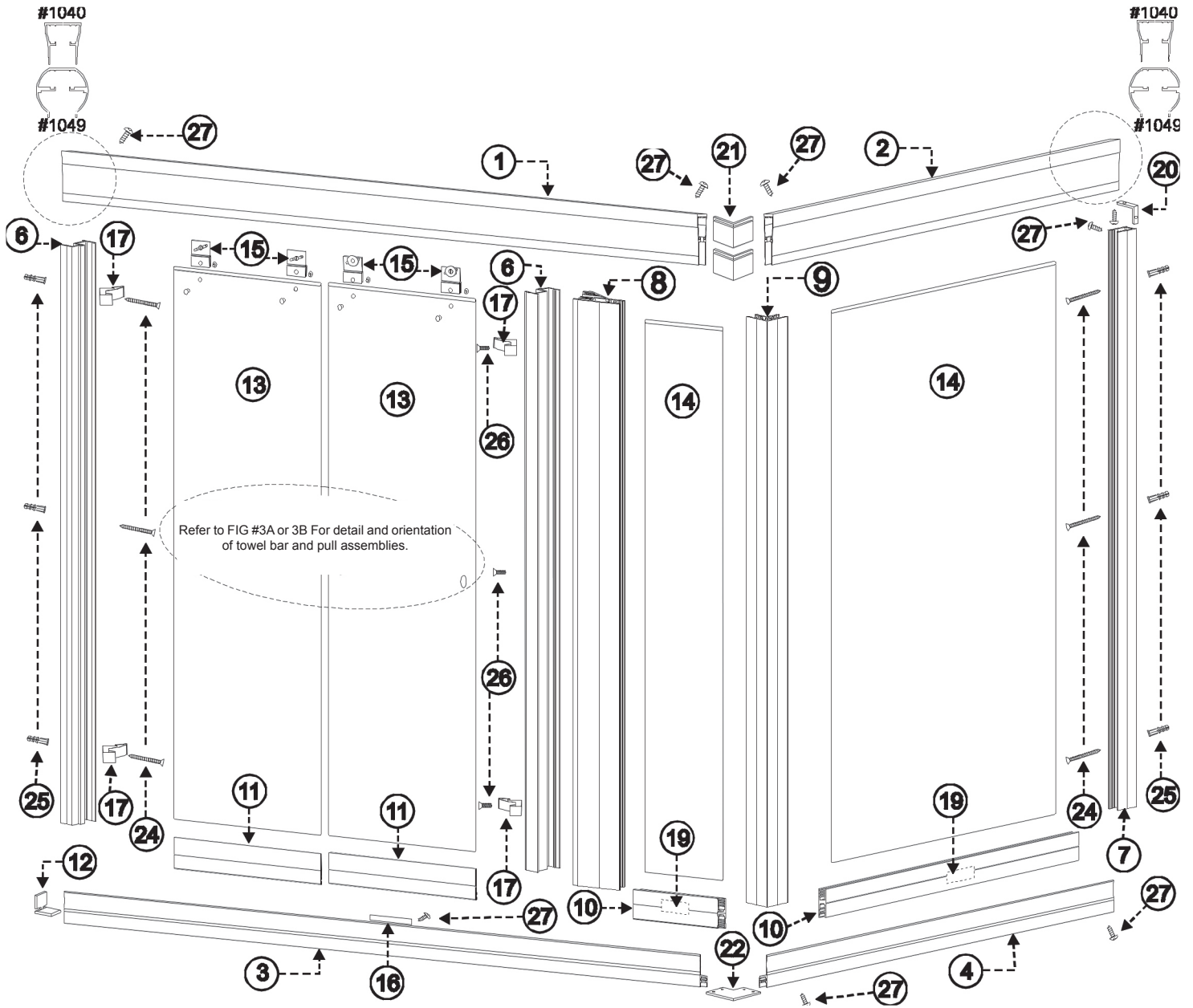
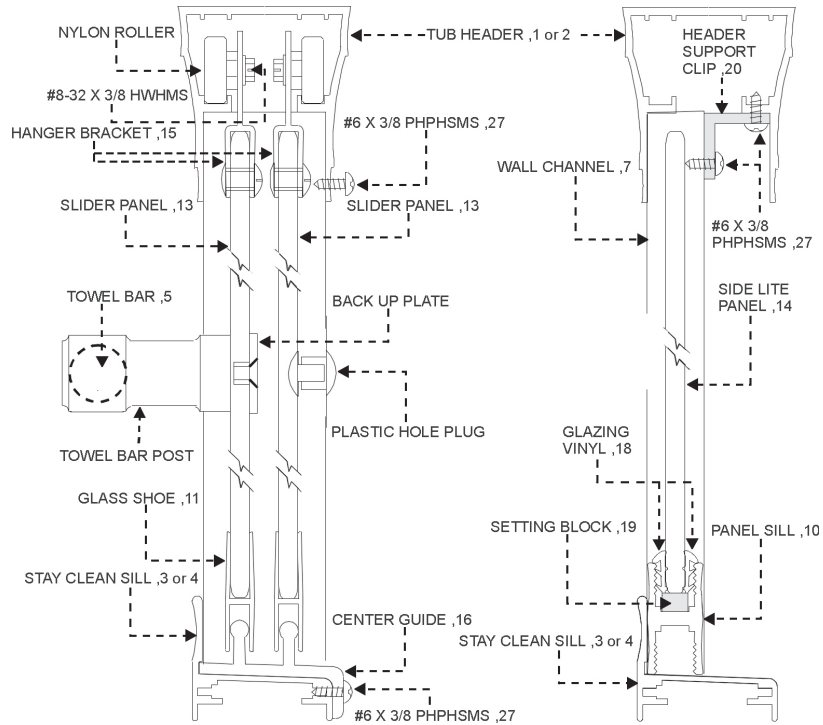

Figure #1 - ATE-ASE & UTE-USE 290 Shower Door Assembly



**Figure # 2 - Shower Door Assembly - Side View**



**Figure # 3a - Shower Door Assembly - Top View**

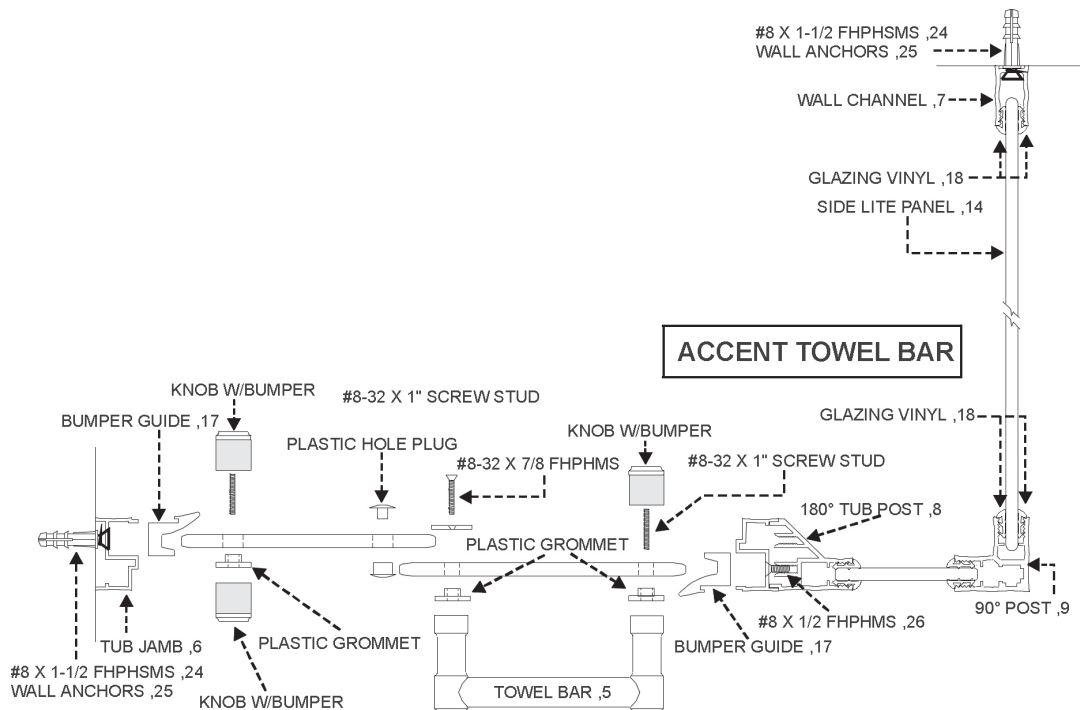

**Figure # 3b - Euro Towel Bar  
(Instructions in Towel Bar package)**

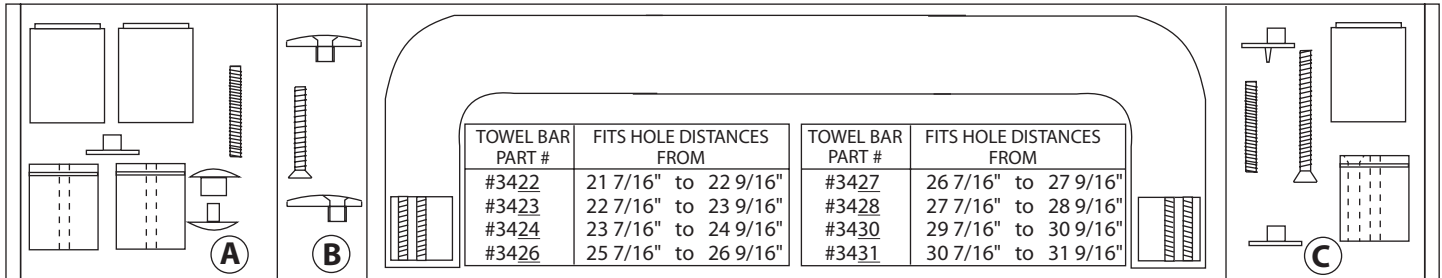

Back to Back Knobs, Hole Plug (Package A)

Towel Bar Back Plates (Package B)

Towel Bar (See size chart above for Part Number)

Towel Bar Knob (Package C)

**Figure # 4**

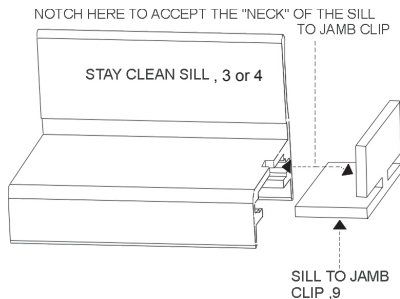

**Figure # 5**

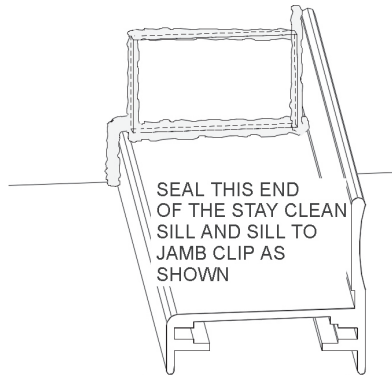

**Figure # 6**

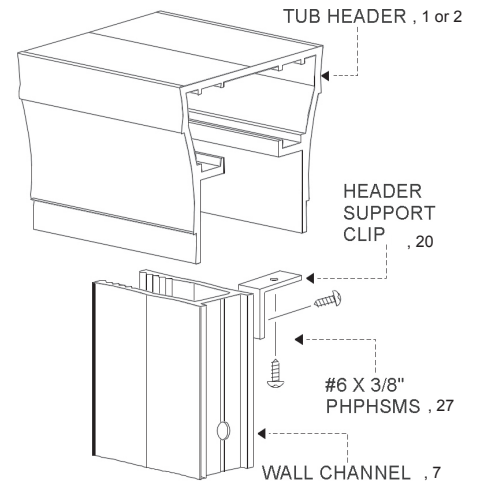

**FIG. #7 - Top View - Looking down at the sill with panel installed in header.**

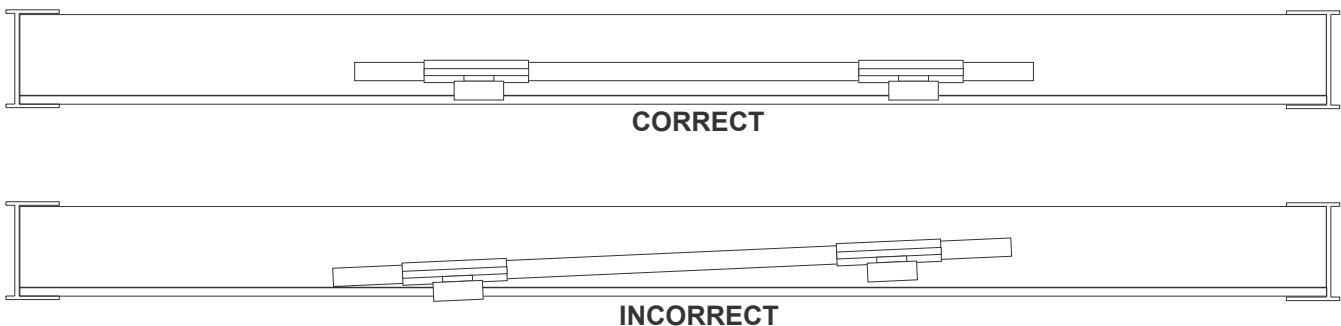

**Installation Instructions for the  
Accent/Euro Collection Two-Panel Sliding Enclosure.  
Model: ATE-ASE & UTE-USE 290  
Drawing Number: 6150 Rev. Date: 09-05-07**



## 6150 - ATE-ASE & UTE-USE 290 Parts List

ITEM #	PART #	DESCRIPTION	QTY.	ITEM #	PART #	DESCRIPTION	QTY.
1	1040/1049	Tub Header LS	1	15	2108	#8 X 3/8 HWHMS	4
2	1040/1049	Tub Header RS	1	15	2212	Female Fastener	4
3	1120	Stay Clean Sill LS	1	15	2109	#6-32 X 5/16 THMS	4
4	1120	Stay Clean Sill RS	1	16	2205	AVG-1 Center Guide	1
5	1200/3010	Towel Bar	1	17	2208	AVB-2 Bumper Guide	4
6	1042	Tub Jamb	2	18	4013	VS-3 Glazing Vinyl	8
7	1026	Wall Channel	1	19	2203	Glass Setting Block	2
8	1023	180° Tub Post	1	20	2019	Header Support Clip	1
9	1028	90° Post	1	21	2013	90° Tub Header Clip	4
10	1032	Panel Sill	2	22	2006	90° Stay Clean Sill Plate	1
11	1121	Glass Shoe	2	23	2216	5/64" Allen Wrench	1
12	2008	Sill to Jamb Clip	1	24	2101	#8 X 1-1/2" FHPHMS	6
13	7002	Sliding Glass Panel	2	25	2217	Wall Anchor	6
14	7006	Side Lite Panel	2	26	2106	#8-32 X 1/2" FHPHMS	3
15	2256	Hanger Bracket Assy.	4	27	2102	#6 X 3/8" PHPHMS	8
15	2214	3/4" Nylon Roller	4	28	2215	Adjustment Wrench	1

## 6150 - ATE-ASE & UTE-USE 290 Assembly Instructions



### SAFETY WARNING:

These installation instructions must be followed to ensure proper operation of the door and to reduce the risk of serious injury. Any deviation from these instructions can result in a serious safety hazard.

All exposed ends of aluminum that are rough, sharp or jagged due to the metal being cut, drilled or damaged should be deburred, smoothed or rounded by the installer before installation. Failure to do so could result in serious injury to the user of the enclosure.

Any part of the swinging glass panels hitting any unprotected bathroom obstruction or metal or glass component of the shower door itself, may indicate improper installation and could lead to serious injury. Installers must correct the deficiencies before allowing the door to be used.



### STEP 1 - STAY CLEAN SILL:

On the shower base, mark the centerline of the unit. **NOTE: Your sill sections may already be cut to length from the factory.** If not, measure each centerline distance. Add 13/16" to each measurement and transfer to the appropriate sill sections (Item #3 & 4). **NOTE: All dimensions on the sill and header are measured from the tip, (farthest point), of the 45° miter.** Be sure to select the sill that is mitered in the direction for the side that you are measuring. At this time, cut only the sill sections to their installed lengths. Straight cut the butt ends opposite the miter to achieve the finished length. **NOTE: it may be necessary to file a radius on the ends of the Stay Clean Sill to fit snugly against the wall.** The Stay Clean Sill must now be notched to accept the Sill to Jamb Clip to help lock the Sill into place. Take the Sill to Jamb Clip (Item #12) and slide it into the end opposite the miter of the Stay Clean Sill that will be on the slider side. Be sure that the clip is positioned (as shown in Fig. #4) with 1/8" x 1/8" "neck" portion of the clip pointing up. Using the clip as a template, mark the neck of the clip onto the sill. Use a standard 1/8" thick medium file to cut a notch that is at least 1/8" deep.

# Installation Instructions for the Accent/Euro Collection Two-Panel Sliding Enclosure.

**Model: ATE-ASE & UTE-USE 290**

**Drawing Number: 6150      Rev. Date: 09-05-07**



## STEP 1 - STAY CLEAN SILL (Continued):

This will allow the clip to be flush with the end of the sill. The Sill to Jamb Key is only required at the end of the sill that will be under the sliding panels. Position the Center Guide (Item #16) onto the Stay Clean Sill where the sliding panels will go. Measure the width of one Sliding Glass Panel (Item #13). Mark this dimension onto the sill measuring off the notched end of the sill. Set the Center Guide into place and, using the factory hole as template, drill through the hole into the sill with a #32 wire gauge drill bit. NOTE: Do not attach the Center Guide at this time. Assemble the right and left sill sections by sliding the 90° Stay Clean Sill Plate (Item #22) into the slot on the under side of each sill. Hold the miters tightly together and tighten the set screws on the plate using the 5/64" Allen Wrench (Item #23) provided in the parts kit. With the Sill to Jamb Clip in place, set the Stay Clean Sill back onto the tub rim or shower sill. Use a pencil or non-permanent marker to mark the location of the Stay Clean Sill on the tub rim at each point where it meets each wall so that the sill can be repositioned later. Use masking tape to hold the sill in place while proceeding. Apply caulk only to the end of the Stay Clean Sill with the notch at this time. Please refer to Fig. #5 for sealant location.

## STEP 2 - TUB JAMB:

Place one of the Tub Jamb (Item #6) against the wall at the end of the Stay Clean Sill with the notch and clip. IMPORTANT NOTE: The INSIDE sliding panel, when closed, must be the closest panel to the shower head wall. The OUTSIDE panel, when closed, must be away from the shower head wall. The Tub Jamb can be rotated to accept either an inside or an outside panel. Please refer to Fig. #3A for proper orientation. The lower end of the Tub Jamb should rest on the horizontal surface of the Stay Clean Sill and over the vertical leg of the 90° Sill to Jamb Clip. Plumb the Tub Jamb by using a level. Be careful not to disturb the caulking at the end of the Stay Clean Sill. With the jamb plumb, mark all three factory hole locations onto the wall using the Tub Jamb as a template. Carefully remove the Tub Jamb and drill the three holes using a 3/16" drill bit (use a carbide tipped bit if going into tile or other types of masonry materials). Take care that no debris gets into the caulk as you drill. Insert three Wall Anchors (Item #25) into the holes. Replace the Tub Jamb and realign. Position one Bumper Guide (Item #17) over the top and bottom holes and secure the Tub Jamb with three #8 X 1-1/2" FHPHSMS (Item #24).

## STEP 3 - WALL CHANNEL:

Ensure that the Stay Clean Sill is still properly aligned and secured with masking tape. Set the Wall Channel (Item #7) in place on the horizontal surface of the Stay Clean Sill, at the wall opposite the Tub Jamb, up against the vertical edge of the sill with the open edge of channel facing away from wall. Refer to Fig. #3A. Plumb the wall channel with a level. Using the wall channel's pre-drilled holes as a template, mark the three installation holes on the wall. Remove wall channel and drill holes into the wall with a 3/16" drill bit (use carbide tipped bit if going into tile or other types of masonry material). Insert one Wall Anchor (Item #25) into each hole. Next, seal the end of the sill with caulking. Reposition the wall channel, align the holes, and secure with three #8 x 1-1/2" FHPHSMS (Item #24). Take the Header Support Clip (Item #20) and position it flush to the top of, and on the inside of the wall channel. The "L" shape of the clip will point vertically down the wall channel and horizontally away from the channel, toward the inside of the shower. It should be indexed an 1/8" off the wall. See Fig. #6. Using the clip as a template, mark the factory hole location onto the wall channel. Drill the hole with a #32 wire gauge drill bit, then secure with one #6 X 3/8" PHPHSMS (Item #27).

## STEP 4 - 90° SIDELITE PANEL:

Measure the width of the 90° Side Lite Panel and add 1" to the measurement. Cut one Panel Sill, (Item #10), to this dimension. Insert the Setting Block, (Item #19) into the Panel Sill. Set the Panel Sill in place on the Stay Clean Sill and slide it into the Wall Channel. Set the 90° Side Lite Panel into the Panel sill and slide the glass into the Wall Channel. Use masking tape to temporarily keep the Panel sill from sliding off the Stay Clean Sill. Hold the glass panel in place by glazing the top of the panel with a few inches of VS-3 Glazing vinyl, (Item #18). NOTE: Do not cut the vinyl at this time. Set the 90° Post, (Item #9), in place on the Stay Clean Sill and over the edge of the glass panel. Hold the post and panel in place by glazing the top of the panel with a few inches of VS-3 Glazing vinyl, (Item #18). NOTE: Do not cut the vinyl at this time. Secure the bottom of the 90° post to the Stay Clean Sill from the return panel side by drilling through the Stay Clean Sill, into the 90° post, with a #32 wire gauge bit. Be careful not to drill into the glass panel. Secure with one #6 X 3/8" PHPHSMS, (Item #27).

## STEP 5 - 180° SIDELITE PANEL

Take the second Tub Jamb (Item #6) and orient it so that the channel is opposite to the Tub Jamb already in place on the wall. The Tub Jamb that attaches to the 180° Post must be reversed so that the installation holes are to the outside of the shower to accept an outside panel. Lock the Tub Jamb in place onto the 180° Post, flush at both ends and position one Bumper Guide (Item #17) over the top and bottom holes. Secure with three #8-32 X 1/2" FHPHSMS (Item #26). CAUTION: Do not over tighten the screws. Measure the width of one of the sliding panels and multiply by 2. Take this dimension and mark it onto the Stay Clean Sill, measured off the shower head wall.

## Installation Instructions for the Accent/Euro Collection Two-Panel Sliding Enclosure.

Model: ATE-ASE & UTE-USE 290

Drawing Number: 6150 Rev. Date: 09-05-07



Measure the width of the 180° Side Lite Panel and add 1" to the measurement. Cut one Panel Sill, (Item #10), to this dimension. Insert the Setting Block, (Item #19) into the Panel Sill. Set the Panel Sill in place on the Stay Clean Sill and slide it into the 90° Post. Set the 180° Side Lite Panel into the Panel sill and slide the glass into the 90° Post. Use masking tape to temporarily keep the Panel sill from sliding off the Stay Clean Sill. Hold the glass panel in place by glazing the top of the panel with a few inches of VS-3 Glazing vinyl, (Item #18). NOTE: Do not cut the vinyl at this time. Position the 180° Post combination in place on the Stay Clean Sill so that the seam where the two posts come together is on the mark made earlier in this step. (the tub jamb part is on one side of mark and 180° post is on the other side of the mark). Hold the post in place by glazing the top of the panel with a few inches of VS-3 Glazing vinyl, (Item #18). Secure the bottom of the 180° post to the Stay Clean Sill by drilling through the Stay Clean Sill, into the 180° post, with a #32 wire gauge bit. Be careful not to drill into the glass panel. Secure with one #6 X 3/8 PHPSMS, (Item #27).

### STEP 6 - TUB HEADER:

Using a level, plumb the 90° post in both directions. With the post plumb, measure from the outside corner of the post to the wall. Add 5/16" to this measurement for the 1040 header and 11/16" for 1049 header. Mark this dimension on a header section (Item #1 or #2). **NOTE: All dimensions on the header and sill are measured from the tip, (the farthest point) of the 45° miter.** Be sure to select the header that is mitered in the right direction for the side that you are measuring. At this time, cut the header to length by cutting the butt end opposite the miter to achieve the finished length. Repeat this procedure for the second header section. Assemble the right and left header sections with four 90° Tub Header Clips (Item #21). See (Fig. #1). Set headers in place over the vertical posts and Header Support Clip. Be sure that the roller channels of the header are resting firmly on the verticals. Secure the header assembly to the vertical posts from the outside of the shower by drilling through the headers into the 90° Post with a #32 wire gauge drill bit. Secure the 180° Post from the inside of the shower, drilling through the header into the Tub Jamb. Using the same bit, attach the header to the Wall Channel as shown in Fig. #6. Do not to drill or screw into the glass panel. The panel can be moved side to side while drilling. Secure the headers with three #6 X 3/8" PHPSM screws (Item #27). After attachment is complete, center the Side Lite Panels between the posts and glaze with 8 pieces of VS-3 vinyl (Item #18) for the verticals "wet" seal each side of both Panel Sills as shown in Fig. #2. NOTE: The vinyl seals are designed to be tight to provide maximum water protection, and minimize shrinkage due to temperature extremes. If it becomes difficult to push the vinyl in place, lubricate it with glass cleaner to allow easy installation. Do not use any type of grease, oils, or silicone sprays as these will harm the vinyl and will stay in place long after the installation is complete compromising safety as well as water protection.

### STEP 7 - SLIDING PANELS:

Carefully set the inside sliding panel into the shower area on a protective pad, ensuring that it cannot fall. From the outside of the shower, hang the outside Sliding Glass Panel in place in the header. Be sure that the rollers are securely in the roller channel of the Tub Header. From the inside of the shower, hang the inside panel in place assuring that the rollers are securely in the header's roller channel. With both panels in place, slide the Center Guide (Item #16) on the Stay Clean Sill and under the panels. Align with the installation hole that was drilled in Step 1. Secure Center Guide with one #6 X 3/8" PHPSMS (Item #27). Please refer to Fig. #2 for detail.

### STEP 8 - TOWEL BARS AND PULLS:

Agalite has two options for towel bars. Please determine the correct towel bar before proceeding.

**WARNING: The Towel Bar and Knobs / Pulls, should not be installed without grommets. The Grommets prevent the glass from touching the metal screws. If the metal touches the glass, the glass can break and create a serious safety hazard.**

#### ACCENT TOWEL BAR (Figure #3a):

On the outside Sliding Glass Panel, measure center to center between the towel bar holes. Cut the Towel Bar (Item #5) to this dimension. For the pull assemblies, start by sliding the glass panels to their closed position. You will notice that the two center holes are inaccessible because of the overlap in the panels. Make them accessible by sliding each panel to the opposite wall. Now the holes are at the outside edges. Begin installing the pull assemblies with the panels in this position. Start by installing the Male and Female Clear Plastic Hole Plug into the exposed hole on the inside panel. Through the exposed hole on the outside panel, place one Rubber Spacer in the hole followed from the inside with a Back Up Plate and one #8-32 X 7/8" FHPHMS that will thread into the Towel Bar Bracket on the outside of the panel. Follow the detailed drawing in Fig. #3 for proper orientation and assembly. If it is necessary to allow the glass panels to totally bypass each other, contact your Agalite representative and ask for part number 3013 in the appropriate color.

**Installation Instructions for the  
Accent/Euro Collection Two-Panel Sliding Enclosure.**

**Model: ATE-ASE & UTE-USE 290**

**Drawing Number: 6150      Rev. Date: 09-05-07**



ADJUSTABLE EURO TOWEL BAR (Figure #3b):

Please refer to the instructions included in the Towel Bar package

**STEP 9 - SLIDING PANEL ADJUSTMENT:**

If either panel is skewed or rubs against the sill, adjust the panels by loosening the hex nut on any of the Hanger Brackets with the Adjustment Wrench (Item #28) provided in the parts kit, and compensate the panels for the wall conditions. NOTE: The panels do not need to be removed from the header to adjust. Attach the header assembly to the Tub Jambs by drilling, from the inside of the shower, through the header into the Tub Jambs with a 1/8" drill bit. Secure with two #6 X 3/8" PHPSMS (Item #27).

**STEP 10 - CAULK:**

Apply a bead of caulk along the entire inside of the enclosure where it meets the walls and base.