

Installation Instructions

Models: VSE, VTE, CSE or CTE

3/16" Frameless Shower or Tub Slider



P/N MM.5047 (9-18)

This Installation Instruction is a component of the BP.3541.CLR and BP.3037.XXX parts bags.

Thank you for purchasing this outstanding product!
This booklet will help you install your units safely and successfully.

IMPORTANT: Warnings and General Shower Door Information



HEAVY



CAUTION

**SAFETY
WARNINGS:**



SHARP



GLASS FRAGILE

- These instructions must be followed carefully to reduce the risk of serious injury. Any deviation from these instructions can create a serious safety hazard.
- Glass panels are tempered to conform with general building and safety codes. Be very careful handling tempered glass. Especially protect all edges of the glass from contact with hard surfaces.
- All exposed aluminum edges should be deburred to avoid serious injury.

Special Note: Drilling holes and anchoring horizontal sills and curbs into thresholds and tub decks is discouraged because it can cause leaking and water damage below the unit. Use masking tape or double-sided tape to hold components down during installation and then apply silicone for structural support and water protection. Exceptions to this policy are necessary when components are structurally required to be anchored.

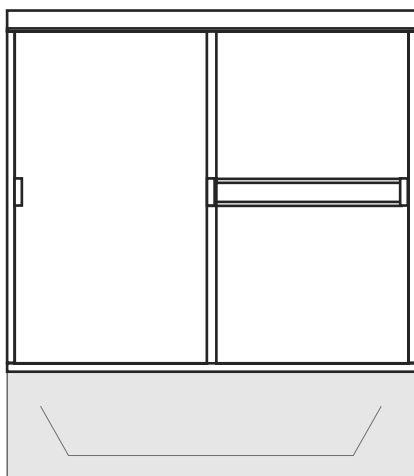

VSE or CSE

3/16" Frameless Shower Enclosure

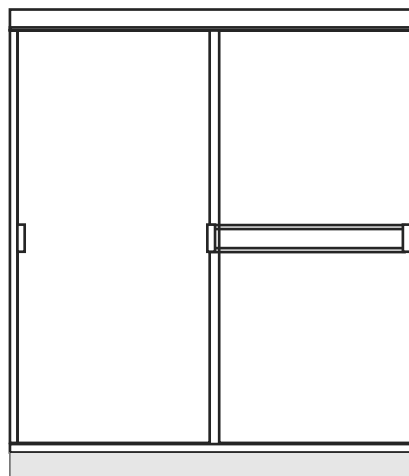

VTE or CTE

3/16" Frameless Tub Enclosure

General Required Tools

- * Pencil or water soluble felt pen
- * Hacksaw with 24 tooth blade
- * Metal file (smooth sharp edges)
- * Tape measure
- * Drill, electric or battery
- * #2 Phillips Screw driver
- * 3/16" Carbide drill bit for tile
- * 1/4" Carbide drill bit for tile
- * Caulking gun
- * Clear 100% Silicone (recommended)
- * 4 ft. Level
- * Rubber mallet
- * Razor knife
- * Blue painters tape

Installation Instructions
Models: VSE, VTE, CSE or CTE
 3/16" Frameless Shower or Tub Slider

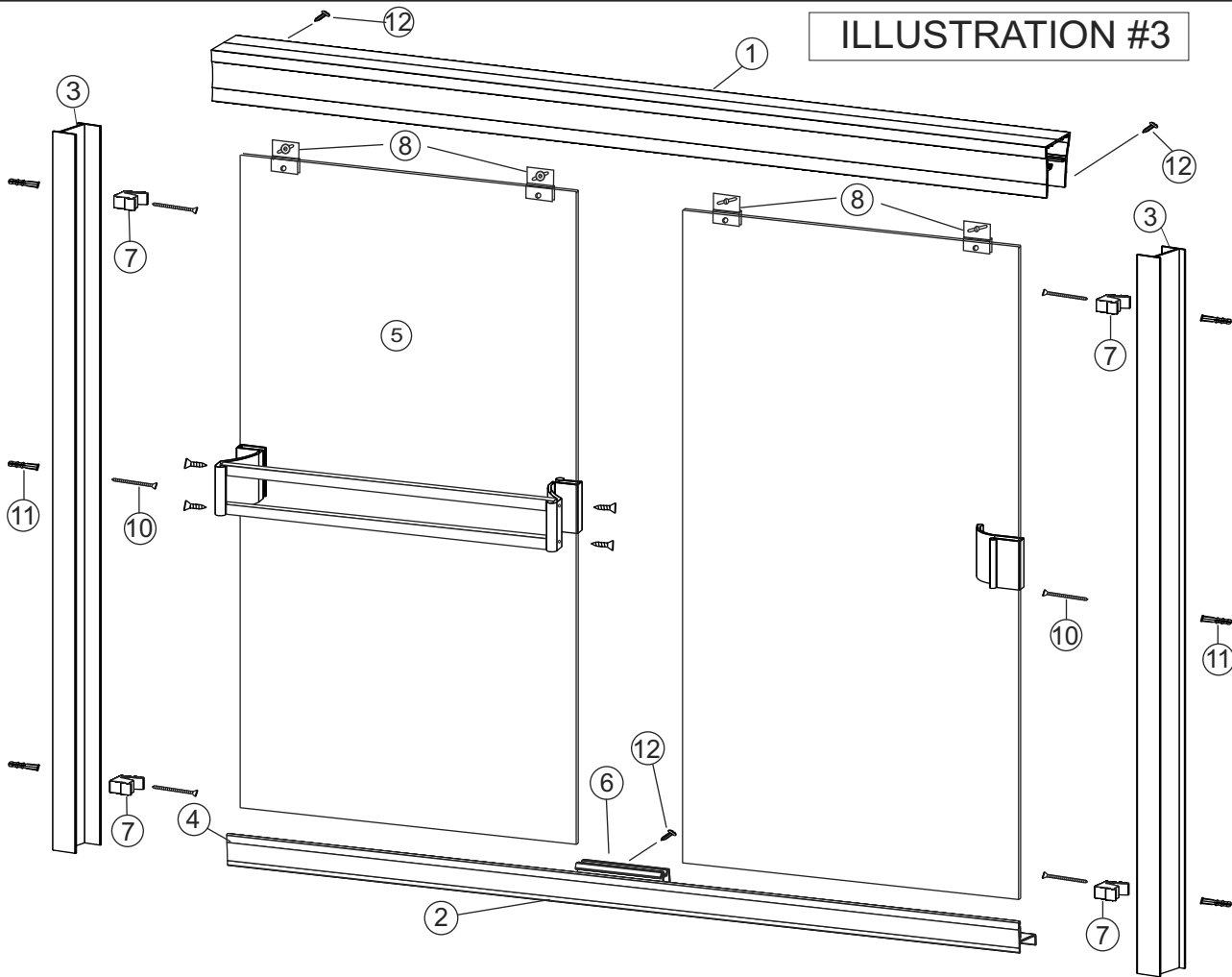

Parts List

Item	Part#	Description	QTY
1	1049/1050	Tub Header	1
2	1062	Stay Clean Sill	1
3	1051	Tub Jamb	2
4	4032	TF-2B T-Fin	1
5	7102	Sliding Glass Panel	2
6	BP.3541	AVG-3 Center Guide	1

Item	Part#	Description	QTY
7	BP.3541	Bumper Guides	4
8	2254	Hanger Bracket Assy	4
9	BP.3027	#6 x 3/8 FHPHMS	4
10	BP.3027	#8 x 1-1/2 FHPHMS	6
11	BP.3027	Wall Anchor	6
12	BP.3027	#6 x 3/8 PHPHMS	3

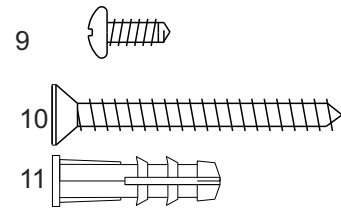

Extra screws may be provided for your convenience

Installation

STEP 1

CENTERLINE:

Locate as accurately as possible the centerline of the shower or tub rim and mark it with a water soluble marker. In most installations, the Stay Clean Sill (Item #2) is installed directly over and parallel to the centerline. Measure the wall to wall distance, 0/100" above the tub rim to allow for any radius or obstructions in the corners. From this measurement, deduct 1/2" and cut the Stay Clean Sill to length.

STEP 2

STAY CLEAN SILL:

Mark the center of the Stay Clean Sill for the Center Guide. Use the Center Guide's hole for a template and mark the location onto the sill. Drill the installation hole with a 1/8" drill bit. See illustration #2. Do not attach the Center Guide at this time. Install the T-Fin into the Stay Clean Sill with the fin pointing down. Flush cut at the ends.

ILLUSTRATION #2

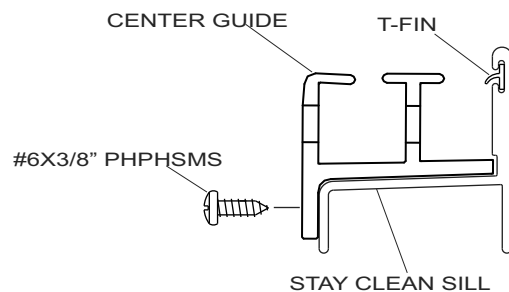

STEP 3

TUB JAMBS:

The Tub Jambs (3) should be installed starting at the shower head wall. Set the Tub Jamb on the shower base and against the wall. Plumb the jamb and using the factory holes as a template, mark the holes onto the wall. Drill the holes with a 3/16" drill bit (carbide bit for masonry). Insert three #8x1-1/2" FHPHSMS (10), attaching a Bumper Guide (7) with the top and bottom screws. See Illust. #3. Be sure to orient the Bumper Guides to accept the proper sliding panel. Set the Stay Clean Sill into place into the secured Tub Jamb at the base. Position and plumb the second Tub Jamb at the base. Position and plumb the second Tub Jamb onto the opposite wall, but mark only the bottom hole. Drill the hole with a 3/16" drill bit. Insert one Wall Anchor and secure Tub Jamb with one #8 X 1-1/2" FHPHSMS (16) and Bumper Guide (12). This will allow the Tub Jamb and Header assembly to move for final adjustment later.

STEP 4

TUB HEADER:

Measure wall to wall at the top of the Tub Jambs and deduct 1/16" and cut Tub Header (1) to length. Set in place over the Tub Jambs but do not secure at this time. Screw size is a #6x3/8" PHPHSMS (18), see illustration #6.

STEP 5

PANEL INSTALLATION:

Make sure that the Tub Jamb with only one screw in it is snug, but still is able to move side to side. Hang the panels in place in the Header starting with what will be the inside panel. Slide it all the way toward the fully secured Tub Jamb. Install the outside panel, making sure that the rollers on both panels are fully seated into the tracks in the header. Finish by installing the Center Guide (11) and securing it with one #6x3/8" PHPHSMS (18).

STEP 6

PANEL ALIGNMENT:

Standing outside the shower, hold the Header at the top where it meets the unsecured Tub Jamb. Be very careful to keep control of the header so that the sliding glass panels can not fall. Slowly move the sliding panels, one at a time, back and forth and into the Tub Jambs, while adjusting the header side to side, seeking a point where the panels pocket perfectly into both Tub Jambs. At this point both Tub Jambs are at identical positions on the wall. Mark the position of the Tub Jamb onto the wall. Slide both panels back to the secured Tub Jamb and remove the Center Guide. Remove both sliding panels and set them in a safe place. Move the Tub Jamb back to the marked location of the wall and mark the final two hole locations. Move the Tub Jamb out of the way just far enough to reveal the marked holes, then drill the holes with a 3/16" drill bit, and insert two Wall Anchors (17). Realign the Tub Jamb and secure with two #8 X 1-1/2" FHPHSMS (16). Reinstall both of the sliding glass panels as you did earlier in the last step, then reinstall the Center Guide.

ILLUSTRATION #4

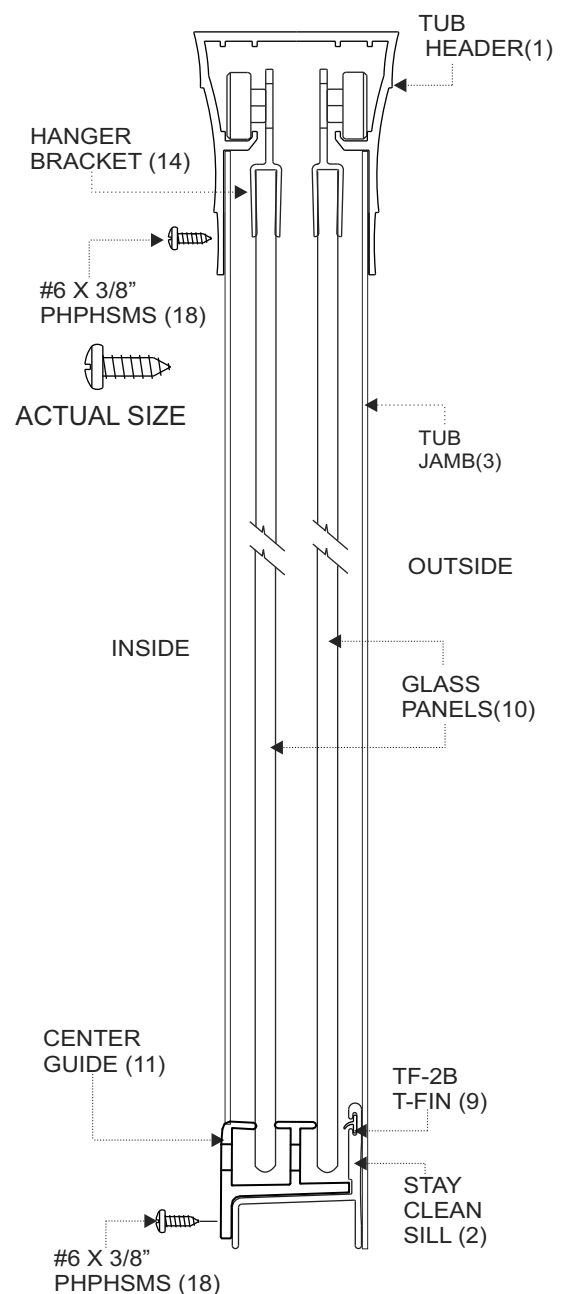

ELEVATION VIEW

STEP 7

TOWEL BARS AND PULLS:

The inside sliding panel, when closed, must be at the shower head wall so that it can deflect water away from the overlap of the panels at the center of the enclosure. Thus, the outside panel must be away from the shower head wall when closed. See illustration #1 on the first page. Follow the instructions included with the towel bar kit on how to install the towel bar and finger pulls.



SAFETY WARNING:

Improper screw placement in STEP 8 could cause damage to the glass (see Illustration #6)

STEP 8

PANEL ADJUSTMENT:

If either of the sliding panels is skewed or rubs against the sill, adjust the panels by loosening the hex nut on any of the Hanger Brackets with the Adjustment Wrench (Item #13), provided in the parts kit. Be sure to re-tighten the screws. **NOTE: The panels can be adjusted while still hanging in the header.** Secure the Header to the Tub Jambs by drilling through the header, from the inside of the shower, into the Tub Jambs with a 1/8" drill bit centered 1/8" from the wall. Secure with two #6 X 3/8" PHPHSMS (Item #18) as shown in illustration #6.

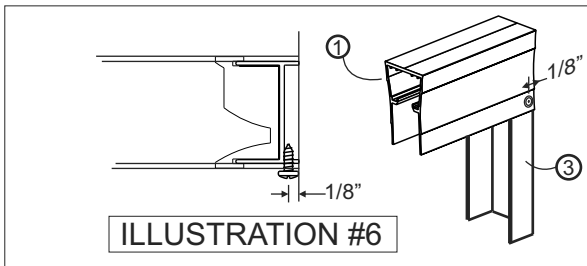

ILLUSTRATION #6

STEP 9

SEALANT:

Apply a bead of sealant along the entire outside of the enclosure where it meets the wall and base. Pay special attention at the bottom corners where the Tub Jambs meet the Stay Clean Sill. These joints must be totally sealed for a leak proof installation.

NOTE:

You may have unused items leftover depending on the desired configuration selected. For installation and technical support please reference the shipping document, the box the product was shipped in, or call the store where you purchased the product.

ILLUSTRATION #5

FRAMELESS GLASS CHART

Overall Height (OAH) for Frameless Sliders:

Tub enclosure Standard Height = 57-1/2"
 Special Height = 55-1/2"

Shower enclosure Standard Height = 70-1/2"
 Special Height = 65-1/2"

Calculating Component sizes

#1050 Tub Jambs = OAH minus 1-3/16"
 #1062 Stay Clean Sill = Overall width minus 3/8"
 #A053 Towel Bar = Glass panel width plus 3/16"
 Glass Panel Width = overall width divided by 2
 Glass Panel height = Overall height minus 2-1/2"

Model Size	Fits Opening	Glass Size (Standard)	Header Pack	Jamb Pack
------------	--------------	-----------------------	-------------	-----------

48	Up to 48"	24" x 55"	48"	56-5/16"
54	48" to 54"	27" x 55"	60"	56-5/16"
56	54" to 56"	28" x 55"	60"	56-5/16"
58	56" to 58"	29" x 55"	60"	56-5/16"
60	58" to 60"	30" x 55"	60"	56-5/16"
66	60" to 66"	33" x 55"	66"	56-5/16"
40	Up to 40"	20" x 68"	48"	69-5/16"
42	40" to 42"	21" x 68"	48"	69-5/16"
44	42" to 44"	22" x 68"	48"	69-5/16"
46	44" to 46"	23" x 68"	48"	69-5/16"
48	46" to 48"	24" x 68"	48"	69-5/16"
54	48" to 54"	27" x 68"	60"	69-5/16"
56	54" to 56"	28" x 68"	60"	69-5/16"
58	56" to 58"	29" x 68"	60"	69-5/16"
60	58" to 60"	30" x 68"	60"	69-5/16"

* Standard glass thickness is 3/16"

** For Standard Special Height units, deduct 2" from the above tub glass heights and 5" from the above shower glass heights. Use these same deductions from the above for the Jamb Pack lengths for Standard Special Height units.