

Installation Instructions

Models: STE / SSE

DTE / DSE

1/4" Frameless Slider



P/N MM.5037
rev061818

This installation sheet is a required component in Parts Bag BP.3541

Thank you for purchasing this outstanding product!
This booklet will help you install your units safely and successfully.

IMPORTANT: Warnings and General Shower Door Information Page 2



HEAVY



CAUTION

**SAFETY
WARNINGS:**



SHARP



GLASS FRAGILE

- These instructions must be followed carefully to reduce the risk of serious injury. Any deviation from these instructions can create a serious safety hazard.
- Glass panels are tempered to conform with general building and safety codes. Be very careful handling tempered glass. Especially protect all edges of the glass from contact with hard surfaces.
- All exposed aluminum edges should be deburred to avoid serious injury.

Special Note: Drilling holes and anchoring horizontal sills and curbs into thresholds and tub decks is discouraged because it can cause leaking and water damage below the unit. Use masking tape or double-sided tape to hold components down during installation and then apply silicone for structural support and water protection. Exceptions to this policy are necessary when components are structurally required to be anchored.

Pick a unit below that best represents your configuration.

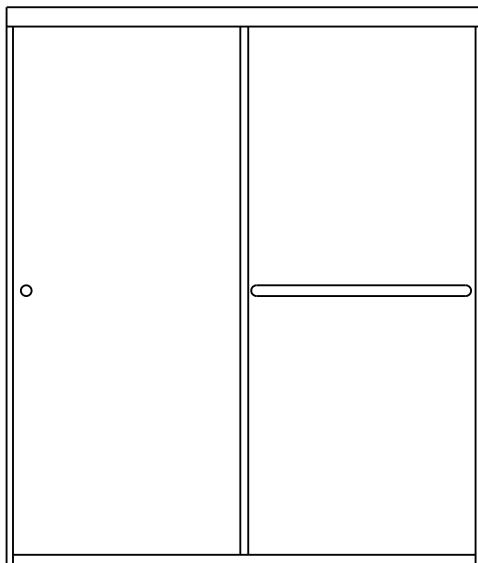

**SSE
DSE**
Shower Slider

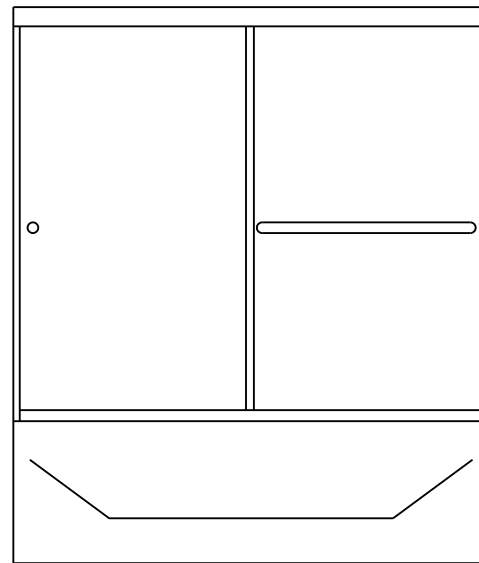

**STE
DTE**
Tub Slider

General Required Tools

- | | | |
|------------------------------------|-------------------------------------|----------------------|
| * Pencil or water soluble felt pen | * #2 Phillips Screw driver | * 4 ft. Level |
| * Hacksaw with 24 tooth blade | * 3/16" Carbide drill bit for tile | * Rubber mallet |
| * Metal file (smooth sharp edges) | * 1/8" Drill bit for metal | * Razor knife |
| * Tape measure | * Caulking gun | * Blue painters tape |
| * Drill, electric or battery | * Clear 100% Silicone (recommended) | * Booklet: MM.5037 |

Installation Instructions
Models: STE / SSE or DTE / DSE
 1/4" Frameless Slider

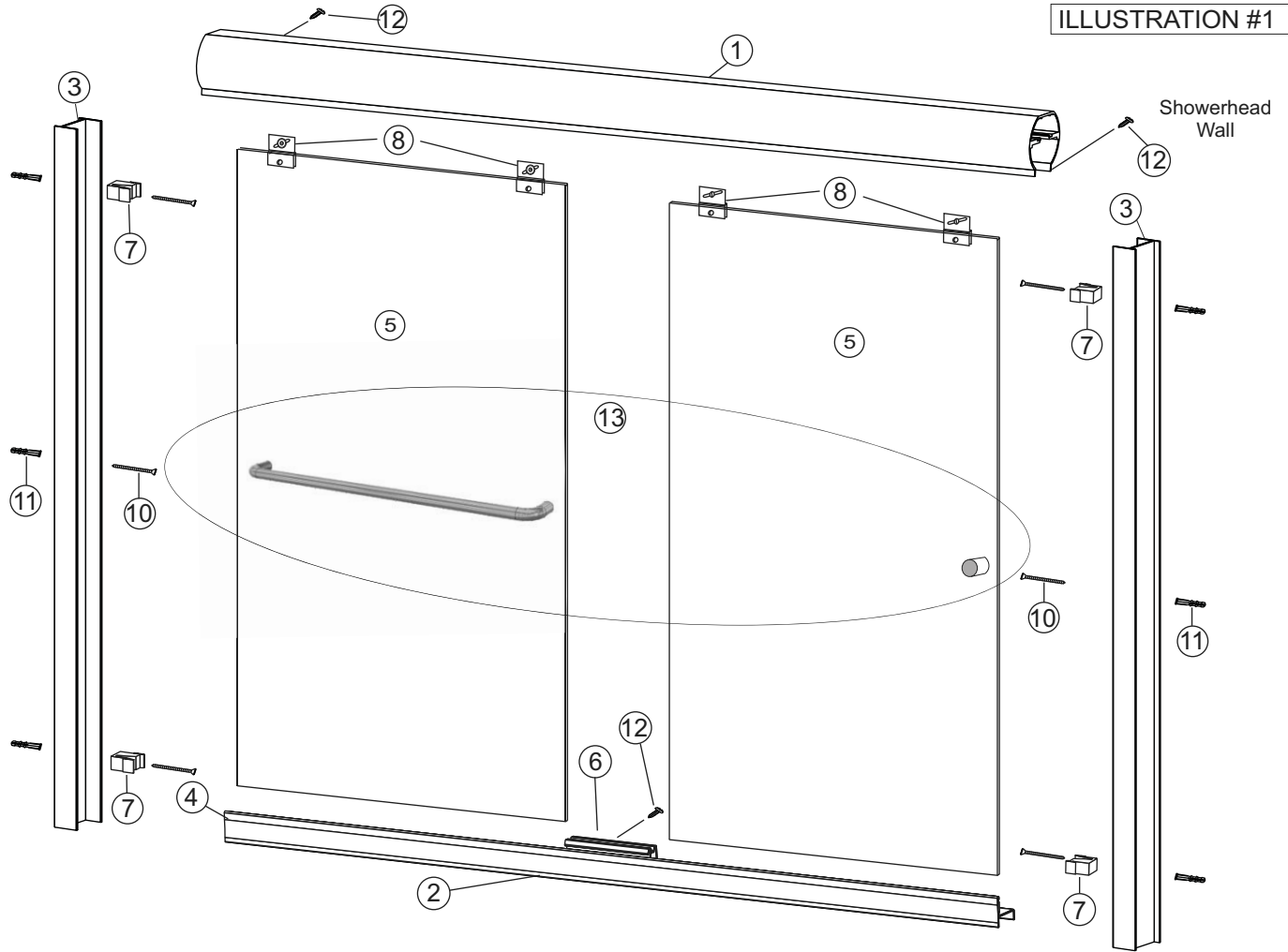

Parts List

Item	Part #	Description	QTY
1	1049	Tub Header	1
2	1062	Stay Clean Sill	1
3	1051	Tub Jamb	2
4	4032	TF-2B T-Fin	1
5		Sliding Glass Panel	2
6	BP.3541	AVG-3 Center Guide	1

Item	Part #	Description	QTY
7	BP.3541	Bumper Guides	4
8	2256	Hanger Bracket Assy	4
10	BP.3027	#8 x 1-1/2 FHPHMS	6
11	BP.3027	Wall Anchor	6
12	BP.3027	#6 x 3/8 PHPHMS	3

Item	Part #	Description	QTY
13	HA.27XX	Towel Bar/Screw Kit	1
14	BP.3000	Anti jump Bag	1

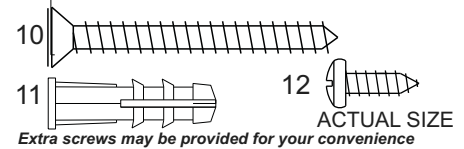

Installation

STEP 1 - CENTERLINE:

- Locate the centerline of the shower or tub rim and mark it with a water soluble marker. See illustration #3 (page 3)
- The Stay Clean Sill (Item #2) is installed directly over and parallel to the centerline
- Measure the wall to wall distance, 1/2" above the threshold to allow for any radius or obstructions in the corners
- Deduct 7/16" from this measurement and cut the Stay Clean Sill (2) to length

ILLUSTRATION #2

STEP 2 - STAY CLEAN SILL:

- Mark the center of the Stay Clean Sill (2) for the Center Guide (6).
- Use the Center Guide's (6) hole for a template and mark the location onto the sill. See illustration #2.
- Drill hole with a 1/8" drill bit.
- Do not attach the Center Guide (6) at this time.
- Install the T-Fin into the Stay Clean Sill (2) with the fin pointing down. Flush cut at the ends.
- Set the Sill (2) in place over the centerline and hold in place with Painters tape.

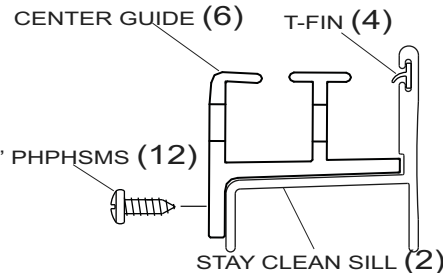

STEP 3 - TUB JAMBS:

- The Tub Jamb (3) opposite the shower head wall is installed first
 - Set Tub Jamb in gap between the Stay Clean Sill (2) and wall
 - Plumb the jamb
 - Mark only the bottom Tub Jamb hole using the factory hole as a template
 - Drill the hole with a 3/16" drill bit (carbide bit for masonry)
 - Insert one Wall Anchors (11) into the tile. See Illustration #1
 - Insert a Bumper Guide (7) and 1 - #8x1-1/2" FHPHSMS (10) into bottom hole
 - Orient Bumper Guide with panel crevice to outside. Illustration #4
 - Tighten screw until snug.
 - Secure top of jamb to wall on both sides with painter's tape
-
- Position and plumb the second Tub Jamb onto the opposite wall,
 - Plumb with a level and mark all three holes.
 - Drill the holes with a 3/16" drill bit. Insert three Wall Anchor (11) and secure Tub Jamb with three #8 X 1-1/2" FHPHSMS (10) and 2 - Bumper Guides (7). Panel crevice of these bumper guides should be oriented inside of unit. Illustration #4.

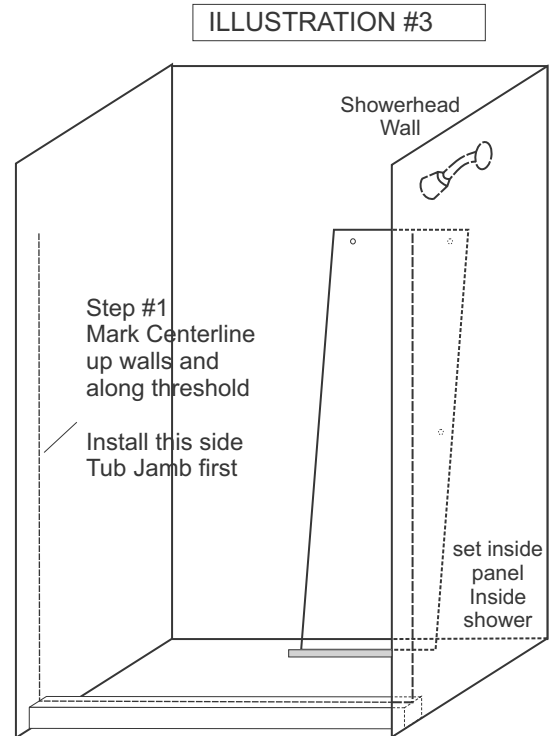

STEP 4 - TUB HEADER:

- Measure wall to wall at the top of the Tub Jambs
- Deduct 1/16" and cut Tub Header (1) to length
- Drill a 1/8" hole at each end on the inside. Screw size is a #6x3/8" PHPHSMS (12), see illustration #5.

-
- Find Parts Bag BP.3000.NTL - Anti-Jump Runners (14) and follow installation instructions (see Illustration #6). *NOTE: Use of runners is encouraged, but optional and must be ordered separately on some units*

-
- Set header in place over the Tub Jambs but do not secure at this time.

STEP 5- PANEL INSTALLATION:

- Make sure that the Tub Jamb opposite the showerhead (only one screw) is snug, and secured with painters tape
- Place inside panel (Knob Panel) inside the shower or tub stall. Lean against the back wall. Use pad to protect the glass/tile from damage. See Illustration #3
- Hang outside panel (Towel Bar Panel) in place in the and slide to showerhead wall (fully secured Tub Jamb)
- Install the inside panel and slide to wall opposite shower head
- Ensure rollers on both panels are fully seated into the header tracks
- Install the Center Guide (11) and securing it with one #6x3/8" MS (12).

STEP 6 - PANEL ALIGNMENT and FINAL PANEL INSTALLATION:

- Standing outside the shower, slowly move the sliding panels one at a time into the proper Bumper Guides (7) and Tub Jambs (3)
- Adjust the header side to side (you will have to remove and reapply painter's tape) until both panels pocket perfectly into both Tub Jambs
- When the panels pocket perfectly, mark the remaining two holes of the Tub Jamb onto the wall opposite the showerhead
- Slide both panels back to the showerhead Tub Jamb
- Remove the Center Guide
- Remove both sliding panels and set them in a safe place on a padded surface.
- Move the Tub Jamb out of the way just far enough to reveal the marked holes and drill the holes with a 3/16" drill bit
- Insert two Wall Anchors (11)
- Realign the Tub Jamb and secure with two #8 X 1-1/2" FHPHSMS (10). Ensure you install the top Bumper Guide (7) when you install the top screw
- Reinstall both of the sliding glass panels as you did earlier in the last step, then reinstall the Center Guide

ILLUSTRATION #4

Bumper Guide orientation for showerhead right

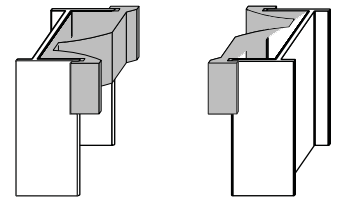

Reverse above orientation for showerhead left

ILLUSTRATION #5

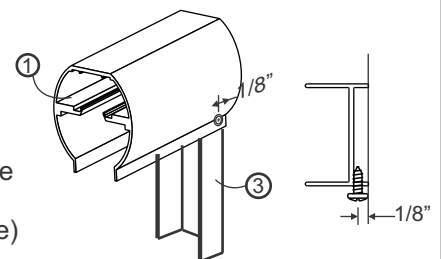
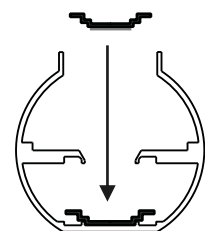
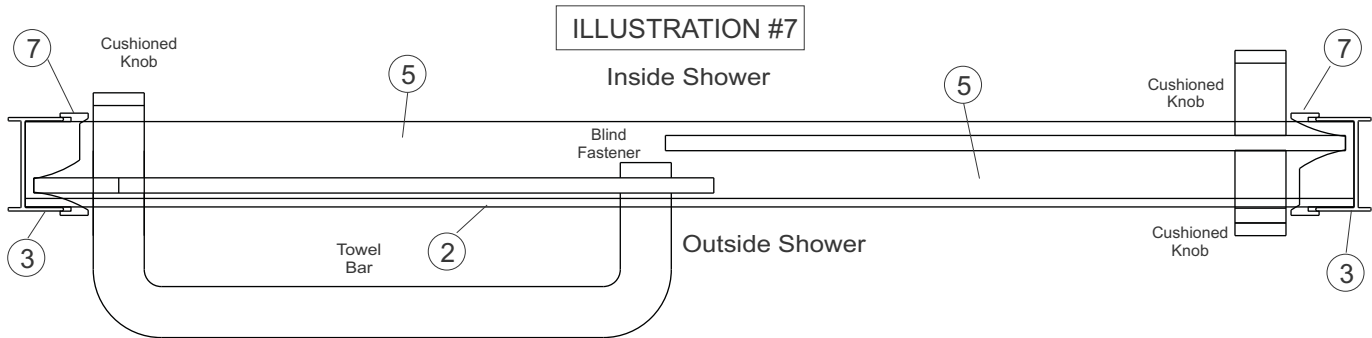

ILLUSTRATION #6



Anti Jump Runner
w/ Red Tape

Installation Instructions
Models: STE / SSE or DTE / DSE
 1/4" Frameless Slider



Top view shows towel bar and knob locations for a shower head on right wall.
 If the shower head is on the left the panels would be reversed.

STEP 7 - TOWEL BARS AND KNOBS:

- Refer to Illustration #7 for typical Euro Towel Bar installation for an showerhead right enclosure
- Refer to the instruction sheet that came with your door for more detailed instructions

STEP 8 - PANEL ADJUSTMENT:

- To adjust the sliding panels for out-of-square wall conditions or to level them, etc., locate the hex nuts in the Hanger Brackets (8) and the Adjustment Wrench provided in the parts kit. See Illustration #8

NOTE: The panels can be adjusted while still hanging in the header.

- Loosen the hex nut with the special wrench until roller can slide along the angled slot on the Hanger Bracket (8)
- Raise or lower each side of the panel by sliding the roller along the angled slot until desired adjustment is achieved
- Be sure to re-tighten the screws.

STEP 9 - HEADER ATTACHMENTS:

- Secure the Header to the Tub Jambs by drilling through the holes in the header, from the inside of the shower, into the Tub Jambs with a 1/8" drill bit.
- Secure with two #6 X 3/8" PHPHMS (Item #12) as shown in illustration #8.



SAFETY WARNING:

Improper screw placement during STEP 9 could cause damage to the glass.

STEP 10 - SEALANT:

- Apply a bead of sealant along the entire outside of the enclosure where it meets the wall and base.
- Pay special attention at the bottom corners where the Tub Jambs meet the Stay Clean Sill. These joints must be totally sealed for a leak proof installation.

