

Installation Instructions for STE/SSE180 or DTE/DSE180

1/4" Slider w/ 180° Panel

FIRST STEPS - Identify the model number of your unit.

- Look on the white shipping label on the outer cardboard box.
- **Model number** on label should correspond to one listed above.

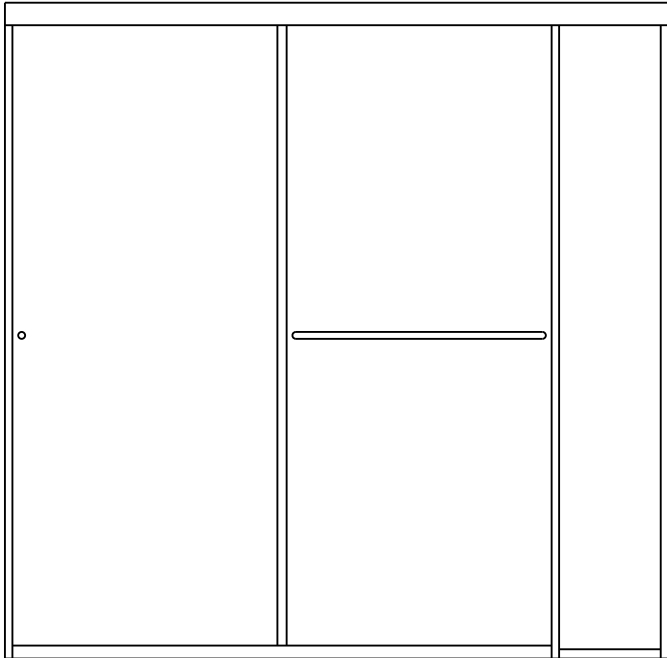

SSE/DSE180

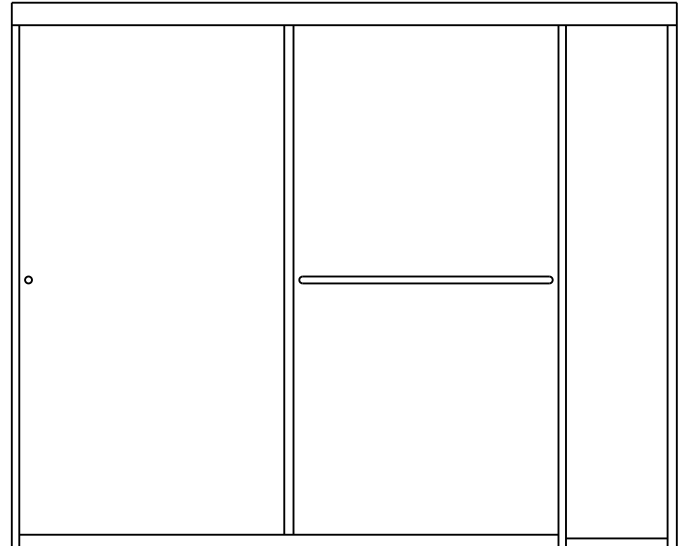

STE/DTE180

NOTE:

- Installation procedures are the same for tub or shower height units
- The images in this manual show an arrangement with the showerhead to the left. The same instructions apply for the opposite orientation where the examples would be reversed.

Required Tools

* Pencil or water soluble felt pen

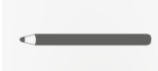

* Hacksaw with 24 tooth blade

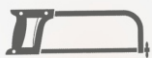

* Metal file (smooth sharp edges)



* Tape measure



* Clear 100% Silicone (recommended)



* #2 Phillips Screw driver



* 1/8" 3/16", drill bits (carbide for tile)



* Caulking gun



* Drill, electric or battery



* 4 ft. Level



* Rubber mallet



* Razor knife



P/N MM.5038
rev061920

READ ENTIRE MANUAL BEFORE INSTALLATION AND OPERATION

Warnings and General Shower Door Information



**SAFETY
WARNINGS:**



READ AND FOLLOW INSTRUCTIONS: Failure to follow all instructions, warnings and guidelines may result in serious injury or death, may cause water damage, and will void the terms of your warranty.

General Safety and Installation Policies

Before Installation:

- **Proper Size:** Ensure the enclosure is the proper size for your opening prior to beginning installation.
- **Safe Installation:** Some units may require two or more people to safely install the enclosure properly.
- **Packaging:** It is recommended to retain all packaging and other materials until installation is complete in the event of a return.
- **Inspect:** Installer should inventory all parts or components and inspect them for damage prior to beginning installation.
- **Sharp Edges:** Exposed ends of aluminum and other hard components can be rough, sharp or jagged due to the processes of cutting, drilling, notching, etc. Sharp ends must be deburred, smoothed or rounded by the installer before installation.
- **Safety equipment and tools:** Have all necessary safety equipment (glasses and gloves) and proper tools for the installation. The installer is responsible for determining the correct drill bit(s) for the installation.
- **New Tile:** We recommend that you allow at least 2 days (48 hours) for the tile cement and grout to dry before installing enclosure.

During Installation



- **Proper backing:** Shower doors are heavy. Therefore, glazing channels, fillers, hinges and headers blocks (structural components) should be secured to studs or solid backing beneath the tile or decorative substrate. Fasteners should screw directly into the backing. Wall anchors are provided primarily to separate screws from tile to reduce the possibility of cracking.

- **Tempered glass:** Glass can break. Shower door panels are tempered to ASTM C1048 specifications as required by building codes. Glass is tempered to greatly increase its strength and to make it fragment into smaller and lighter pieces reducing the possibility of injury in the event that the glass does break. Tempered glass will break and may cause bodily injury if you attempt to cut, drill, mill or alter it in any way. Care must be taken when handling tempered glass. Pay special attention to protect all edges of the glass from contact with hard surfaces.
- **Horizontal surfaces and installation holes:** Avoid drilling into the horizontal surfaces of tubs or showers unless it is required for the structural integrity of the unit. If you drill into horizontal surfaces, always generously caulk the holes, anchors, screws and on top of the screw head. If this is not done, or is done improperly, water damage can occur under the tile or substrate.
- **Weep holes in horizontal channels:** Drilling 3/8" weep holes on the inside of horizontal channels is recommended to allow any moisture build-up inside a channel to exit the channel. Due to varying installation conditions and installer's/owner's personal preference, however, we do not drill them in the factory.
- **Sliding and swinging glass doors:** A door may be improperly installed if it hits or scrapes against bathroom obstructions (toilets or cabinets) or any metal or glass components of the shower door itself. This could lead to glass breakage or serious injury. The installer must correct the deficiencies before allowing the door to be used.
- **Surface conditions:** Most shower door designs allow for out-of-square or unlevel installation. Generally, any outage more than 3/8" that was not identified during the ordering process is outside of these allowances and can result in an improper installation.

Caulking/Siliconing the Unit:

- Always clean all contact surfaces before caulking and use a high grade 100% silicone for best results.
- After installation, at a minimum, caulk the entire outside perimeter of the unit where the unit touches walls, sills, and step-ups, etc. Also caulk any vertical joints between metal components where water build-up inside of the channels could leak out.

After Installation:

- **Curing times:** Adhere to manufacturers' recommended curing times for VHB tapes, silicones and any other adhesives, coatings or chemicals used during installation. Unless otherwise stated, it is recommended to wait 72 hours before using the enclosure.
- **Normal wear and tear:** Although these enclosures are designed to last for years, certain items (such as the polycarbonate seals and door sweeps) may need to be replaced as they show signs of aging and wear.

General Disclaimers

- **Shower Doors are not watertight:** Consumers should understand that a shower door is not watertight. The amount of water that can escape your shower can vary greatly based on shower/tub size, configuration of shower head(s), type of thresholds and drains and by the type of shower door itself. Heavy glass units with no or limited vinyl seals, for example, can allow water to escape under normal conditions. Doors with more metal and seals generally provide more water protection. Excessive water pressure or directing shower heads or hand held sprays directly at doors or joints is not a normal shower conditions and can result in leaks.
- **Towel bars, handles and accessories** are in no way considered to be grab bars or other bracing or fall prevention mechanisms. The intent of these accessories is to facilitate proper operation or enhance the esthetics and functionality of the unit.

Owners Manual:

Refer to your Owners Manual for general installation and cleaning and care instructions. If a copy of the Owners Manual was not included, you can download one on the RESOURCES page of our website.

Questions or Comments:

1-800-843-3332

SLIDING TUB / SHOWER ENCLOSURE WITH STATIONARY INLINE PANEL

Item	Part #	Description	QTY
1	1040	Tub Header	1
2	1062	Stay Clean Sill	1
3	1051	Tub Jamb	1
4	1159	180° Post	1
5	1268	Wall Channel	1
6	1070	Panel Sill (Except Notched Panels)	1
7	2019	Header Support Clip	1
8	7106	Panel	1
9	4013	Thin Vinyl (Not Shown)	4
10	2101	#8 x 1-1/2 FHPHMS	6
11	2217	Wall Anchor	6
12	2102	#6 x 3/8 PHPHMS	6
13		Sliding Glass Panels	2

STEP 1

CENTERLINE:

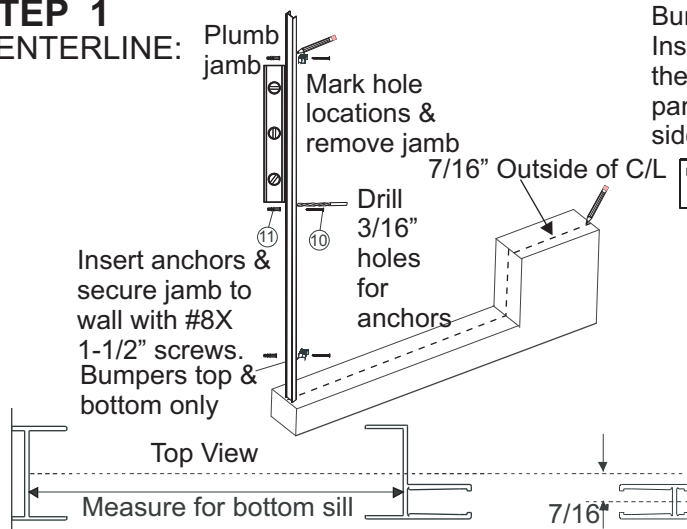

Bumpers are directional. Install the bumpers so that they will receive the inside panel on the shower head side.

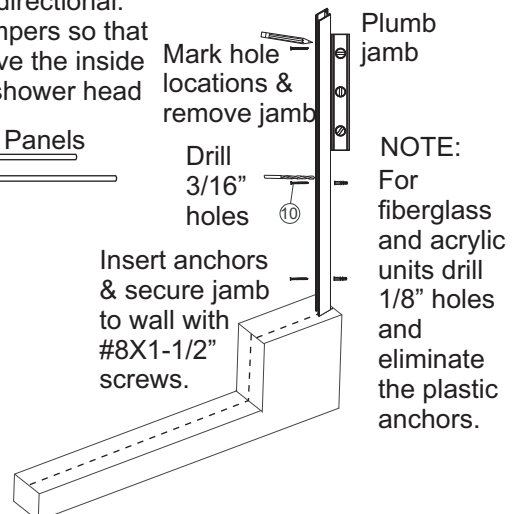

Please refer to the following steps for the stationary panel that you have.

STEP 2A
INSTALLING FULL HEIGHT STATIONARY PANEL & SILL

CENTER GUIDE 2206
(Frameless)

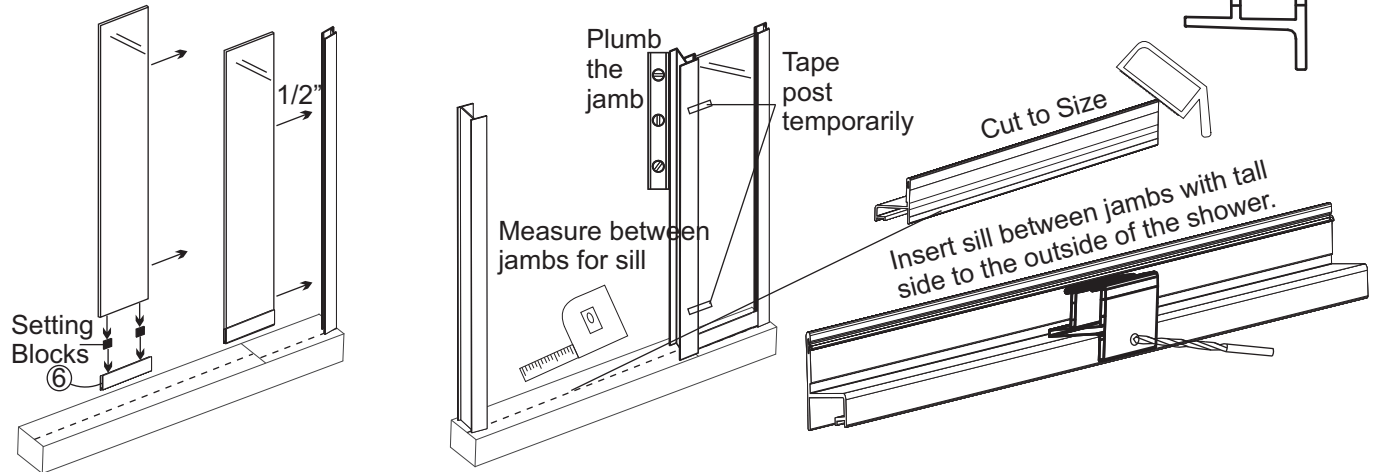

STEP 2B
INSTALLING STATIONARY STEP PANEL & SILL:

CENTER GUIDE 2206
(Frameless)

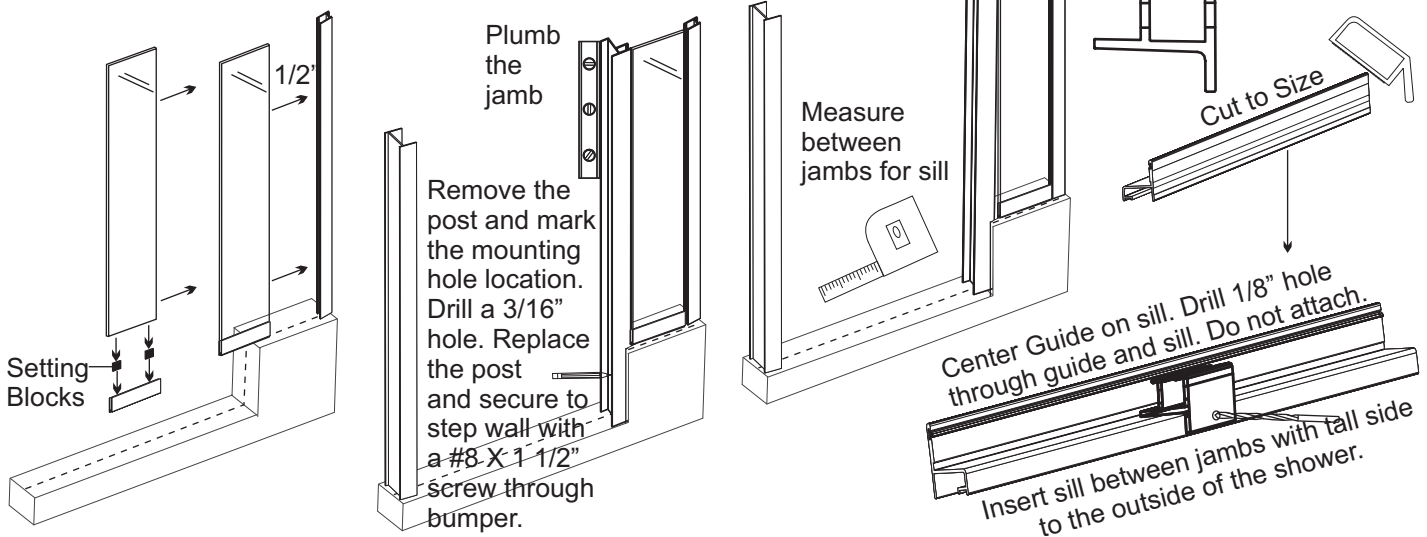

STEP 2C
INSTALLING NOTCHED STATIONARY PANEL & SILL

CENTER GUIDE 2206
(Frameless)

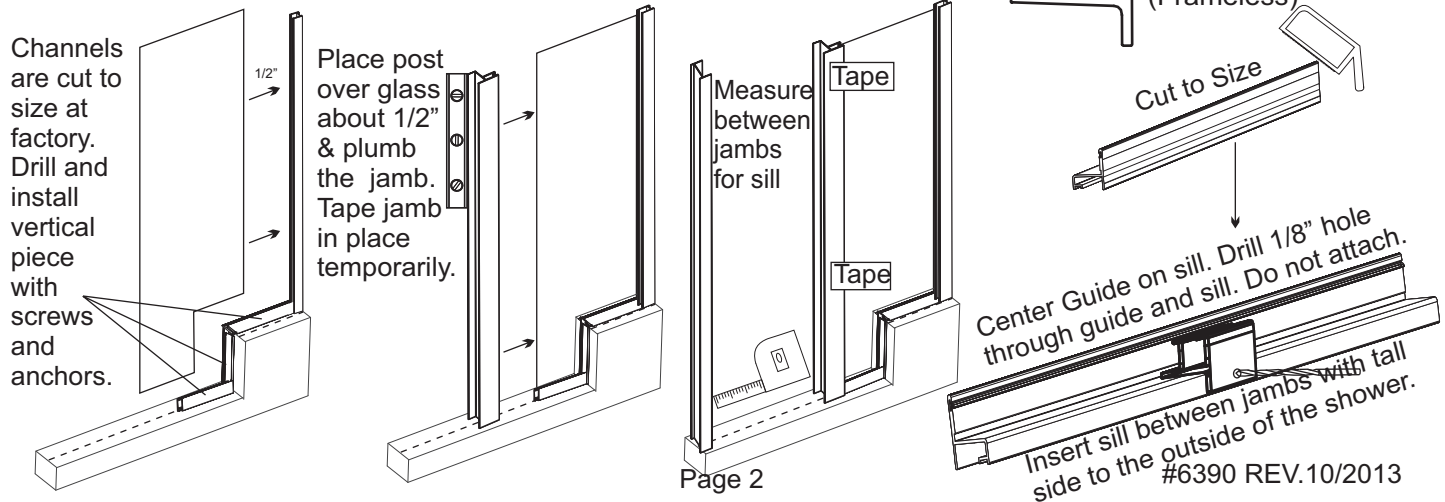

All headers fit onto the top of the units in the same way. The style of header that you have will depend on which unit that have purchased.

STEP 3
HEADER INSTALLATION:

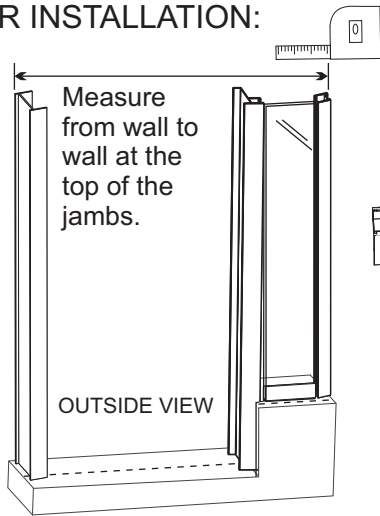

Cut header to size-1/16".

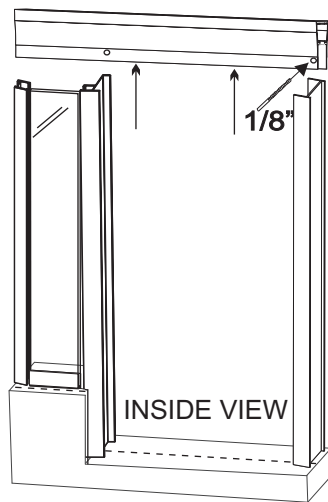
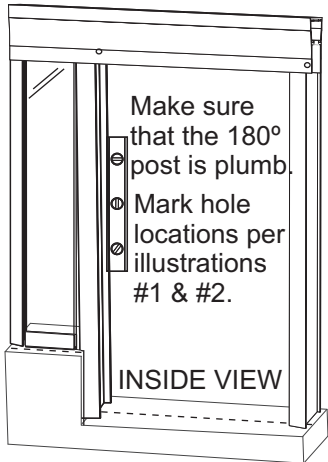
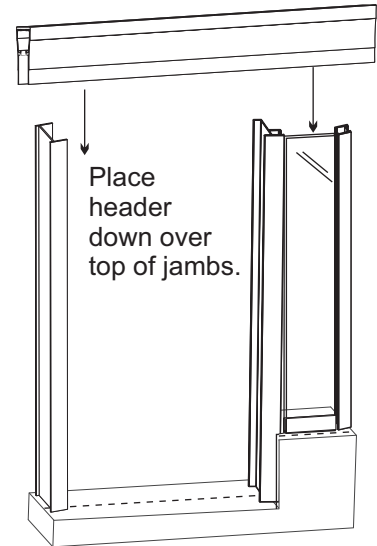
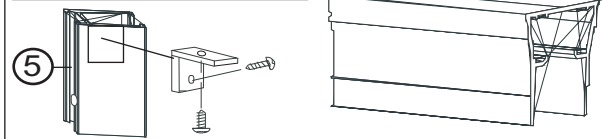
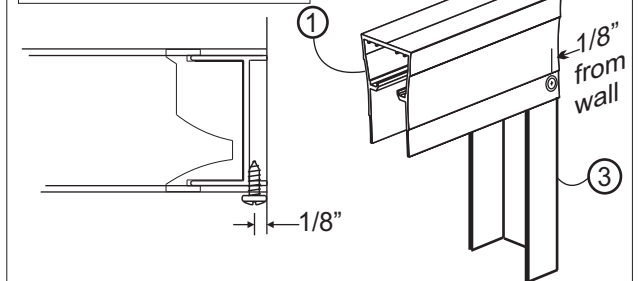

ILLUSTRATION #1



Header support clip mounting location from inside of shower.

ILLUSTRATION #2



Remove the header & drill 1/8" holes in the header at marked locations. Install header clip onto the wall channel. Replace header and drill through holes into jambs. Be very careful to avoid the panel glass. Do not attach.



SAFETY WARNING:

Improper screw placement could cause damage to the glass.

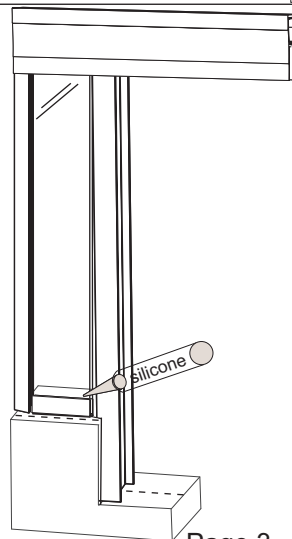
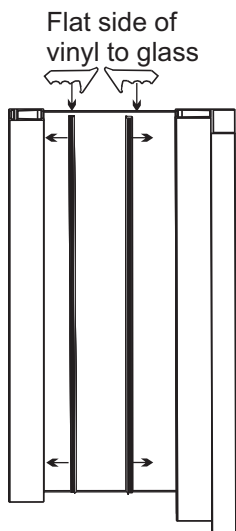

Insert vinyl between glass & vertical channels, on the outside and inside of the panel. If glass is textured, insert the vinyl on the textured side of the glass first. If the vinyl is tight, use soapy water to lubricate the vinyl. A block of wood or plastic may also give some leverage to push the vinyl in between the glass and the channels. After the vinyl is installed, seal the sill with silicone inside and outside and where the channel meets the tile or finish material. Notched panels will use vinyl on the step channels.

SLIDING TUB / SHOWER ENCLOSURE WITH STATIONARY PANEL INLINE

STEP 4

PANEL INSTALLATION:

Place both panels inside of the shower on a padded surface. Install outer panel first by hanging the panel from the rollers on the front channel inside of the header. Hang the inside panel on the on the back channel of the header. The inside panel should always be on the shower head side to prevent water from splashing between panels.

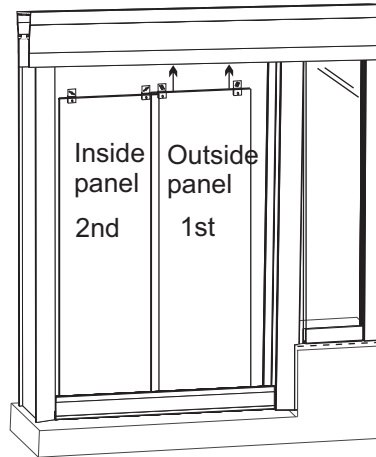
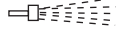

Side View

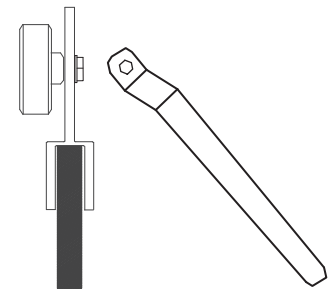

Adjust the rollers in the diagonal slots with the adjustment tool provided if the panels do not meet the jambs evenly, or if the panels drag on the sill or are too high above the sill. Be sure to tight screws securely.

STEP 5

GUIDE INSTALLATION:

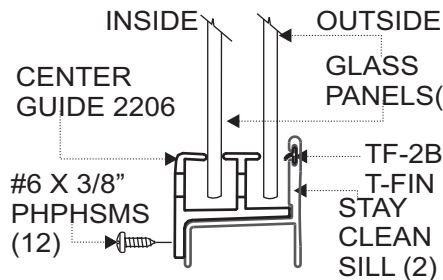

Slide both panels to one side. Install the panel guide by setting the guide on the sill and sliding it under the panels so that the glass fits in the correct slot of the guide. Line the guide up with the hole that was drilled through the guide and sill in step 2. Insert a #6X3/8" pan head screw and carefully tighten until snug. The panels should be just above the guide.

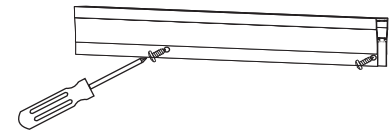

From the inside of the shower, insert the #6 X 3/8" screws to attach the header to the jambs. Make sure the screws do not interfere with the glass panels. Tighten the screws with a screwdriver or reduce the torque on an electric drill to avoid stripping out the holes.

STEP 6 SEALANT:

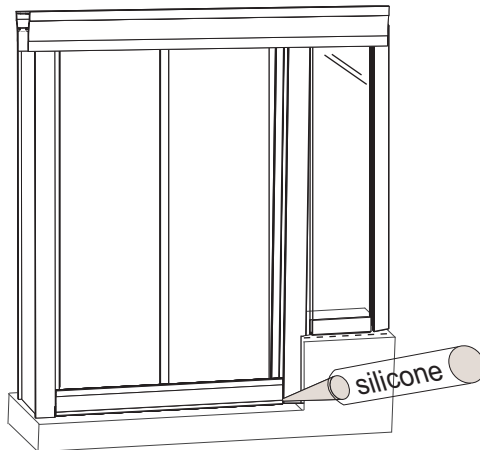

Apply a bead of sealant along the entire outside of the enclosure where it meets the wall and base. Pay special attention at the bottom corners where the Tub Jambs meet the Stay Clean Sill. These joints must be totally sealed for a leak proof installation.

These installation instructions must be followed to ensure proper operation of the door and to reduce the risk of serious injury. Any deviation from these instructions can result in a serious safety hazard.



All exposed ends of aluminum that are rough, sharp or jagged due to the metal being cut, drilled or damaged should deburred, smoothed or rounded by the installer before installation. Failure to do so could result in serious injury to the user of the enclosure.

NOTE:

You may have unused items leftover depending on the desired configuration selected. For installation and technical support please reference the shipping document, the box the product was shipped in, or call the store where you purchased the product.