

# Installation Instructions for ESE/ETE or ELSE/ELTE

3/8" Bypass Slider

BP.3544.CLR - Estate Slider Guide Kit Clear

**FIRST STEPS** - Identify the model number of your unit.



- Look on the white shipping label on the outer cardboard box.
- **Model number** on label should correspond to one listed above

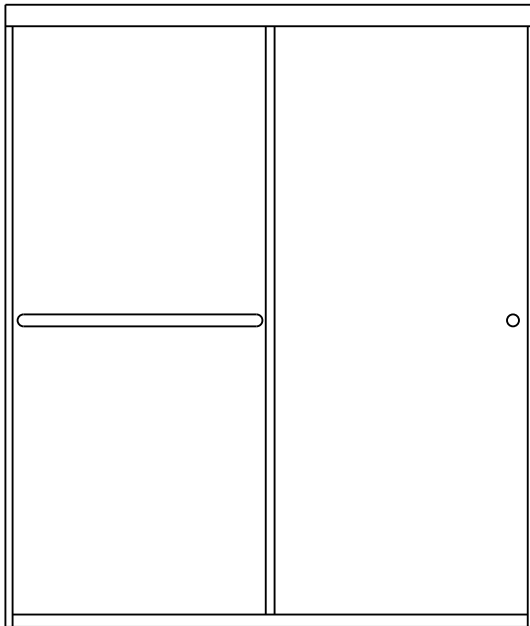

**ESE  
ELSE**  
Shower Slider

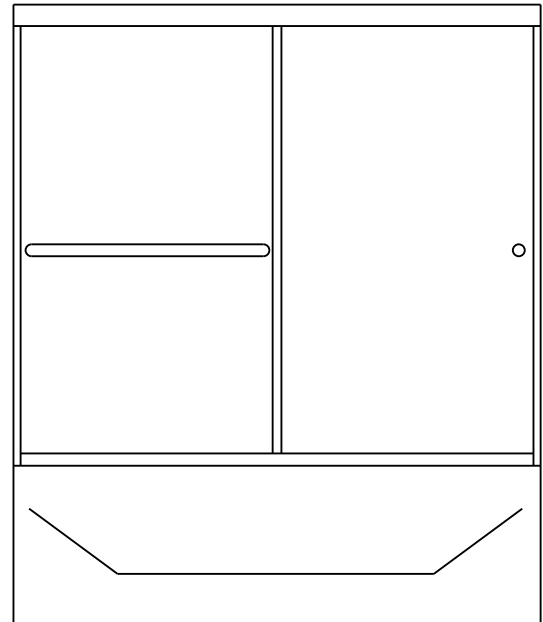

**ETE  
ELTE**  
Tub Slider

## IMPORTANT NOTES:

- Installation procedures in this manual are identical for tub or shower height units
- This installation manual depicts an installation with the shower head on the right shower wall
- For an installation where the shower head is on the left, use the same sequence of steps, but, reverse the side that the referenced part are installed on as needed
- If hanger brackets are not attached to the sliding panels, or are installed incorrectly, follow instruction on page 6 of these instructions

## Required Tools

\* Pencil or water soluble felt pen

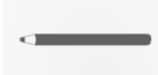

\* Hacksaw with 24 tooth blade

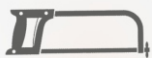

\* Metal file (smooth sharp edges)



\* Tape measure



\* Clear 100% Silicone (recommended)



\* #2 Phillips Screw driver



\* 1/8", 3/16", 1/4", 3/8" drill bits (carbide for tile)



\* Caulking gun



\* Drill, electric or battery



\* 4 ft. Level



\* Rubber mallet



\* Razor knife



This installation sheet is a required component in Parts Bag BP.3544



P/N MM.5017  
rev072820

# READ ENTIRE MANUAL BEFORE INSTALLATION AND OPERATION

## Warnings and General Shower Door Information



**SAFETY  
WARNINGS:**



**READ AND FOLLOW INSTRUCTIONS:** Failure to follow all instructions, warnings and guidelines may result in serious injury or death, may cause water damage, and will void the terms of your warranty.

## General Safety and Installation Policies

### Before Installation:

- **Proper Size:** Ensure the enclosure is the proper size for your opening prior to beginning installation.
- **Safe Installation:** Some units may require two or more people to safely install the enclosure properly.
- **Packaging:** It is recommended to retain all packaging and other materials until installation is complete in the event of a return.
- **Inspect:** Installer should inventory all parts or components and inspect them for damage prior to beginning installation.
- **Sharp Edges:** Exposed ends of aluminum and other hard components can be rough, sharp or jagged due to the processes of cutting, drilling, notching, etc. Sharp ends must be deburred, smoothed or rounded by the installer before installation.
- **Safety equipment and tools:** Have all necessary safety equipment (glasses and gloves) and proper tools for the installation. The installer is responsible for determining the correct drill bit(s) for the installation.
- **New Tile:** We recommend that you allow at least 2 days (48 hours) for the tile cement and grout to dry before installing enclosure.

### During Installation



- **Proper backing:** Shower doors are heavy. Therefore, glazing channels, fillers, hinges and headers blocks (structural components) should be secured to studs or solid backing beneath the tile or decorative substrate. Fasteners should screw directly into the backing. Wall anchors are provided primarily to separate screws from tile to reduce the possibility of cracking.

- **Tempered glass:** Glass can break. Shower door panels are tempered to ASTM C1048 specifications as required by building codes. Glass is tempered to greatly increase its strength and to make it fragment into smaller and lighter pieces reducing the possibility of injury in the event that the glass does break. Tempered glass will break and may cause bodily injury if you attempt to cut, drill, mill or alter it in any way. Care must be taken when handling tempered glass. Pay special attention to protect all edges of the glass from contact with hard surfaces.
- **Horizontal surfaces and installation holes:** Avoid drilling into the horizontal surfaces of tubs or showers unless it is required for the structural integrity of the unit. If you drill into horizontal surfaces, always generously caulk the holes, anchors, screws and on top of the screw head. If this is not done, or is done improperly, water damage can occur under the tile or substrate.
- **Weep holes in horizontal channels:** Drilling 3/8" weep holes on the inside of horizontal channels is recommended to allow any moisture build-up inside a channel to exit the channel. Due to varying installation conditions and installer's/owner's personal preference, however, we do not drill them in the factory.
- **Sliding and swinging glass doors:** A door may be improperly installed if it hits or scrapes against bathroom obstructions (toilets or cabinets) or any metal or glass components of the shower door itself. This could lead to glass breakage or serious injury. The installer must correct the deficiencies before allowing the door to be used.
- **Surface conditions:** Most shower door designs allow for out-of-square or unlevel installation. Generally, any outage more than 3/8" that was not identified during the ordering process is outside of these allowances and can result in an improper installation.

### Caulking/Siliconing the Unit:

- Always clean all contact surfaces before caulking and use a high grade 100% silicone for best results.
- After installation, at a minimum, caulk the entire outside perimeter of the unit where the unit touches walls, sills, and step-ups, etc. Also caulk any vertical joints between metal components where water build-up inside of the channels could leak out.

### After Installation:

- **Curing times:** Adhere to manufacturers' recommended curing times for VHB tapes, silicones and any other adhesives, coatings or chemicals used during installation. Unless otherwise stated, it is recommended to wait 72 hours before using the enclosure.
- **Normal wear and tear:** Although these enclosures are designed to last for years, certain items (such as the polycarbonate seals and door sweeps) may need to be replaced as they show signs of aging and wear.

## General Disclaimers

- **Shower Doors are not watertight:** Consumers should understand that a shower door is not watertight. The amount of water that can escape your shower can vary greatly based on shower/tub size, configuration of shower head(s), type of thresholds and drains and by the type of shower door itself. Heavy glass units with no or limited vinyl seals, for example, can allow water to escape under normal conditions. Doors with more metal and seals generally provide more water protection. Excessive water pressure or directing shower heads or hand held sprays directly at doors or joints is not a normal shower conditions and can result in leaks.
- **Towel bars, handles and accessories** are in no way considered to be grab bars or other bracing or fall prevention mechanisms. The intent of these accessories is to facilitate proper operation or enhance the esthetics and functionality of the unit.

## Owners Manual:

Refer to your Owners Manual for general installation and cleaning and care instructions. If a copy of the Owners Manual was not included, you can download one on the RESOURCES page of our website.

## Questions or Comments:

1-800-843-3332

ILLUSTRATION #1

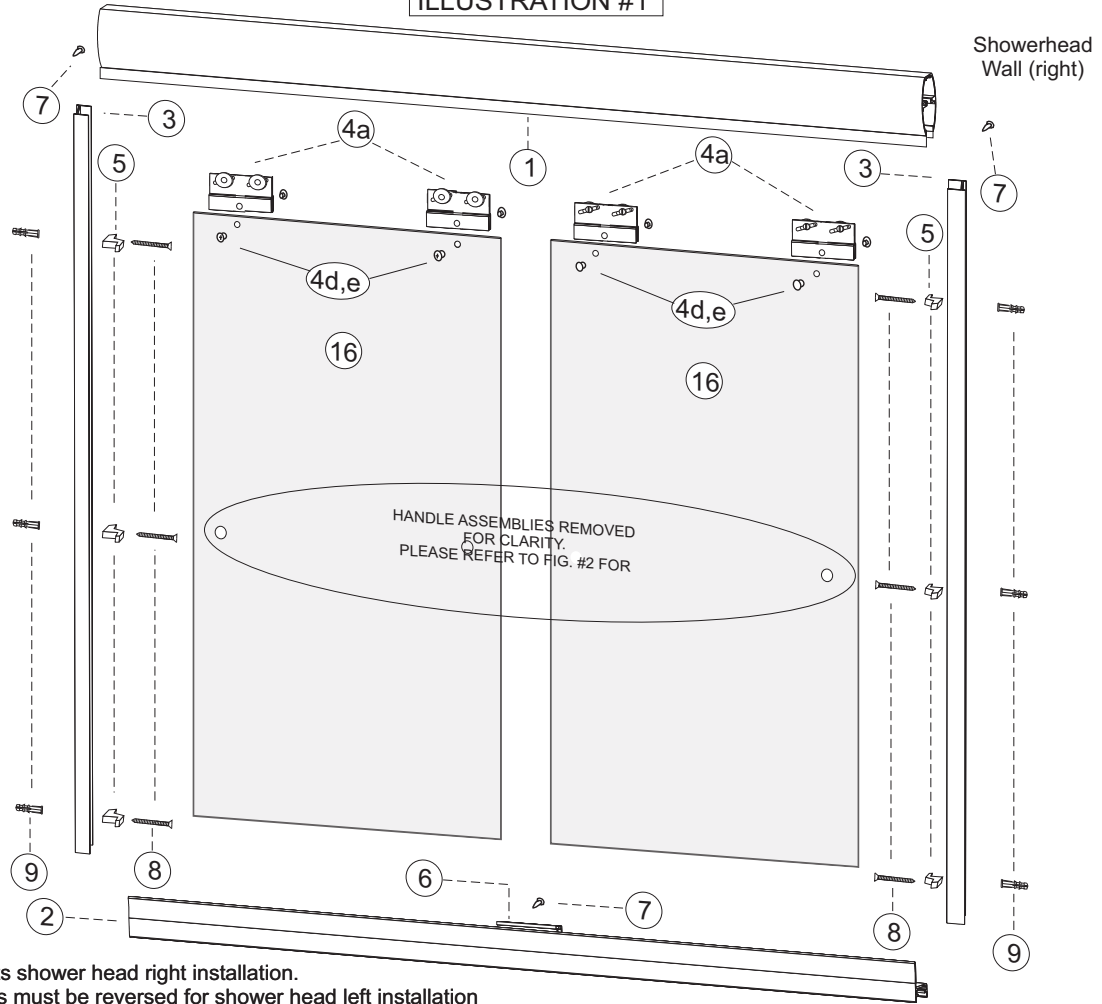

Explode view depicts shower head right installation.  
 Panels and bumpers must be reversed for shower head left installation

**Parts List**

| Item# | Part#   | Description       | Qty. | Item# | Part#   | Description        | Qty. |
|-------|---------|-------------------|------|-------|---------|--------------------|------|
| 1     | 1052    | TUB HEADER        | 1    | 8     | BP.3027 | #8 X 1-1/2 FHPHMS  | 6    |
| 2     | 1062    | STAY CLEAN SILL   | 1    | 9     | BP.3027 | 3/16" WALL ANCHORS | 6    |
| 3     | 1051    | TUB JAMB          | 2    | 10    | HA.27XX | KNOB               | 1    |
| 4a    | BP.3031 | HANGER BRACKET    | 4    | 11    | HA.27XX | KNOB W/ BUMPER     | 2    |
| 4b    | BP.3031 | 3/4" NYLON ROLLER | 4    | 12    | HA.27XX | TOWEL BAR          | 1    |
| 4c    | BP.3031 | #8-32 X 3/8 HWHMS | 4    | 13    | HA.27XX | BACK UP PLATE      | 1    |
| 4d    | BP.3031 | MALE FASTENER     | 4    | 14    | HA.27XX | GROMMET            | 3    |
| 4e    | BP.3031 | FEMALE FASTENER   | 4    | 15    | HA.27XX | THREADED STUD      | 2    |
| 5     | BP.3544 | BUMPER GUIDE      | 6    | 16    | HA.27XX | GLASS PANELS       | 2    |
| 6     | BP.3544 | CENTER GUIDE      | 1    | 17    | 4032    | TF-3 T-FIN         | 1    |
| 7     | BP.3027 | #6 X 3/8 PPHSMS   | 3    | 18    | BP.3544 | ADJUSTMENT WRENCH  | 1    |

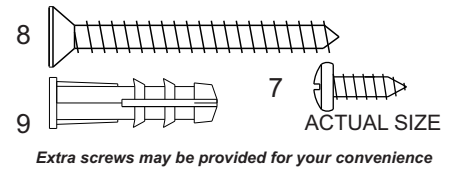

**Installation**

**STEP 1 - CENTERLINE:**

- Locate the centerline of the shower or tub rim and mark it with a water soluble marker. See illustration #3 (page 3)
- The Stay Clean Sill (Item #2) is installed directly over and parallel to the centerline
- Measure the wall to wall distance, 1/2" above the threshold to allow for any radius or obstructions in the corners
- Deduct 7/16" from this measurement and cut the Stay Clean Sill (2) to length

ILLUSTRATION #2

**STEP 2 - STAY CLEAN SILL:**

- Mark the center of the Stay Clean Sill (2) for the Center Guide (6).
- Use the Center Guide's (6) hole for a template and mark the location onto the sill. See illustration #2.
- Drill hole with a 1/8" drill bit.
- Do not attach the Center Guide (6) at this time.
- Install the T-Fin (17) into the Stay Clean Sill (2) with the fin pointing down. Flush cut at the ends.
- Set the Sill (2) in place over the centerline and hold in place with Painters tape.

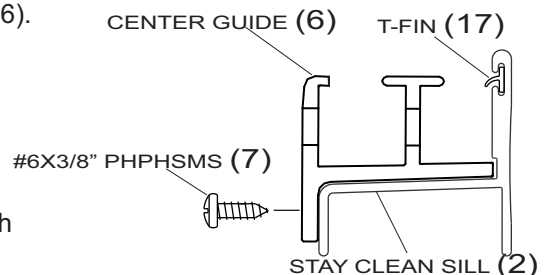

**Installation Instructions**  
**Models: ESE / ETE or ELTE / ELSE**  
 3/8" Frameless Slider

### STEP 3 - TUB JAMBS:

- The Tub Jamb (3) opposite the shower head wall is installed first
- Set Tub Jamb in gap between the Stay Clean Sill (2) and wall
- Plumb the jamb
- Mark only the bottom Tub Jamb hole using the factory hole as a template
- Drill the hole with a 3/16" drill bit (carbide bit for masonry)
- Insert one Wall Anchor (9) into the tile. See Illustration #1
- Insert a Bumper Guide (5) and 1 - #8x1-1/2" FPHSMS (8) into bottom hole
- Orient Bumper Guide with panel crevice to outside. Illustration #4
- Tighten screw until snug
- Secure top of jamb to wall on both sides with painter's tape

- 
- Position and plumb the second Tub Jamb onto the opposite wall,
  - Plumb with a level and mark all three holes
  - Drill the holes with a 3/16" drill bit. Insert three Wall Anchor (9) and secure Tub Jamb with three #8 X 1-1/2" FPHSMS (8) and 2 - Bumper Guides (5). Panel crevice of these bumper guides should be oriented inside of unit. Illustration #4

### STEP 4 - TUB HEADER:

- Measure wall to wall at the top of the Tub Jambs
- Deduct 1/16" and cut Tub Header (1) to length
- Drill a 1/8" hole at each end on the inside. Screw size is a #6x3/8" PHPSMS (7), see illustration #5

- 
- Find Parts Bag BP.3000.NTL - Anti-Jump Runners (19) and follow installation instructions (see Illustration #6). *NOTE: Use of runners is encouraged, but optional and must be ordered separately on some units*

- 
- Set header in place over the Tub Jambs but do not secure at this time

### STEP 5- PANEL INSTALLATION:

- Make sure that the Tub Jamb opposite the showerhead (only one screw) is snug, and secured with painters tape
- Place inside panel (Knob Panel) inside the shower or tub stall. Lean against the back wall. Use pad to protect the glass/tile from damage. See Illustration #3
- Hang outside panel (Towel Bar Panel) in place and slide to showerhead wall (fully secured Tub Jamb)
- Hang the inside panel and slide to shower head wall as well
- Ensure rollers on both panels are fully seated into the header tracks
- Install the Center Guide (6) and securing it with one #6x3/8" MS (7)

### STEP 6 - PANEL ALIGNMENT and FINAL PANEL INSTALLATION:

- Standing outside the shower, slowly move the sliding panels one at a time into the proper Bumper Guides (5) and Tub Jambs (3)
- Adjust the header side to side (you will have to remove and reapply painter's tape) until both panels pocket perfectly into both Tub Jambs
- When the panels pocket perfectly, mark the remaining two holes of the Tub Jamb onto the wall opposite the showerhead
- Slide both panels back to the showerhead Tub Jamb
- Remove the Center Guide
- Remove both sliding panels and set them in a safe place on a padded surface.
- Move the Tub Jamb out of the way just far enough to reveal the marked holes and drill the holes with a 3/16" drill bit
- Insert two Wall Anchors (9)
- Realign the Tub Jamb and secure with two #8 X 1-1/2" FPHSMS (8). Ensure you install the top Bumper Guide (5) when you install the top screw
- Reinstall both of the sliding glass panels as you did earlier in the last step, then reinstall the Center Guide

ILLUSTRATION #3

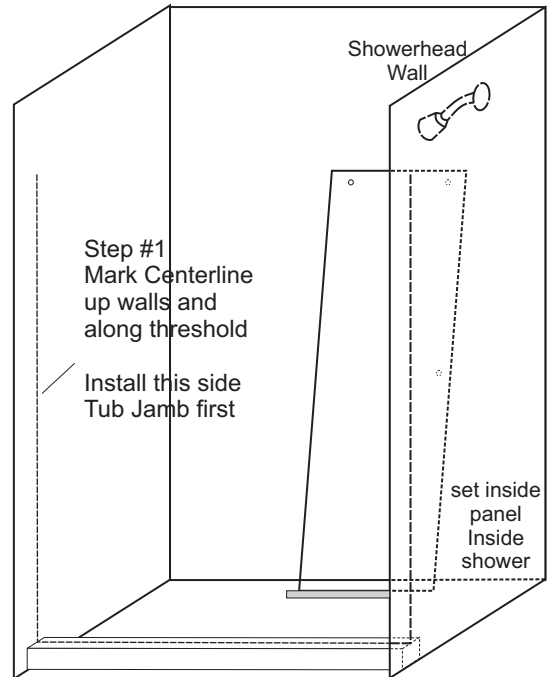
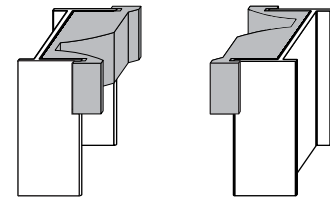

ILLUSTRATION #4

Bumper Guide orientation for showerhead right



Reverse above orientation for showerhead left

ILLUSTRATION #5

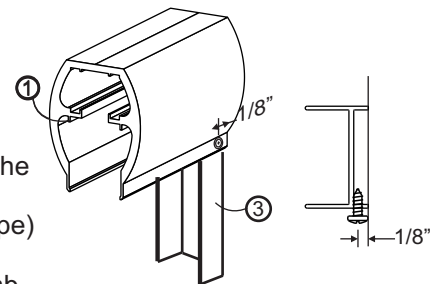
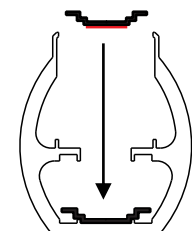
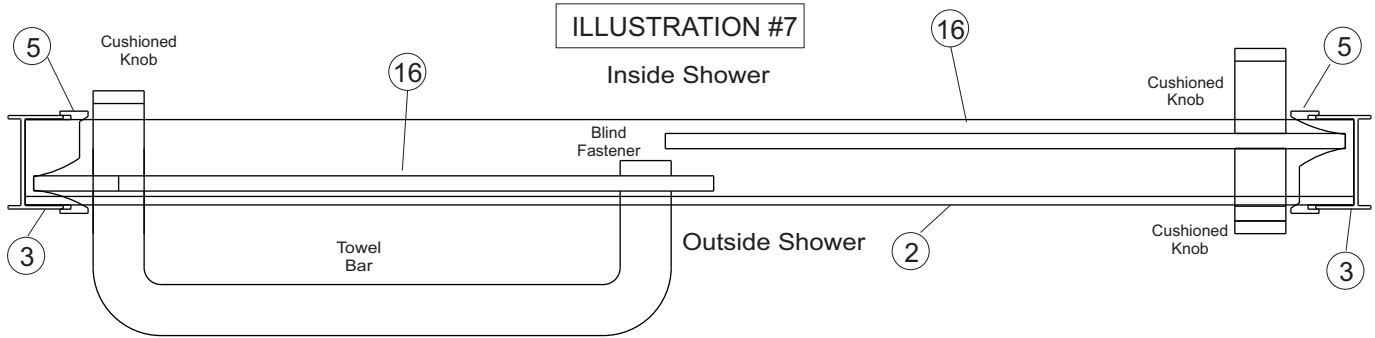

ILLUSTRATION #6



Anti Jump Runner  
w/ Red Tape



Top view shows towel bar and knob locations for a shower head on right wall.  
 If the shower head is on the left the panels would be reversed.

**STEP 7 - TOWEL BARS AND KNOBS:**

- Refer to Illustration #7 for typical Euro Towel Bar installation for an showerhead right enclosure
- Refer to the instruction sheet that came with your door for more detailed instructions

**STEP 8 - PANEL ADJUSTMENT:**

- To adjust the sliding panels for out-of-square wall conditions or to level them, etc., use locate the hex nuts in the Hanger Brackets (4a) and the Adjustment Wrench provided in the parts kit. See Illustration #8

**NOTE: The panels can be adjusted while still hanging in the header.**

- Loosen the hex nut with the special wrench until roller can slide along the angled slot on the Hanger Bracket (4a)
- Raise or lower each side of the panel by sliding the roller along the angled slot until desired adjustment is achieved
- Be sure to re-tighten the screws.

**STEP 9 - HEADER ATTACHMENTS:**

- Secure the Header to the Tub Jambs by drilling through the holes in the header, from the inside of the shower, into the Tub Jambs with a 1/8" drill bit.
- Secure with two #6 X 3/8" PHPHSMS (Item #7) as shown in illustration #8.



**SAFETY WARNING:**

Improper screw placement during STEP 9 could cause damage to the glass.

**STEP 10 - SEALANT:**

- Apply a bead of sealant along the entire outside of the enclosure where it meets the wall and base.
- Pay special attention at the bottom corners where the Tub Jambs meet the Stay Clean Sill. These joints must be totally sealed for a leak proof installation.

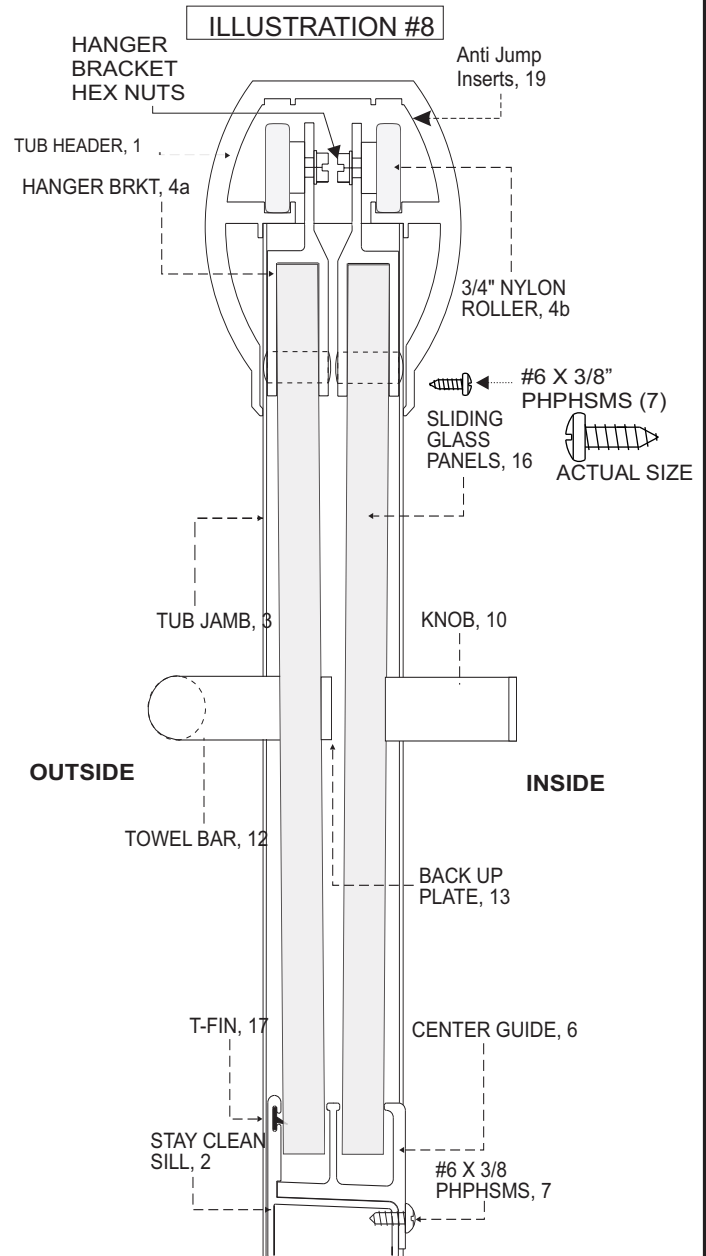

## Hanger Bracket Installation Instructions

Models: ESE / ETE or ELTE / ELSE

3/8" Frameless Slider

## Shower Head Left

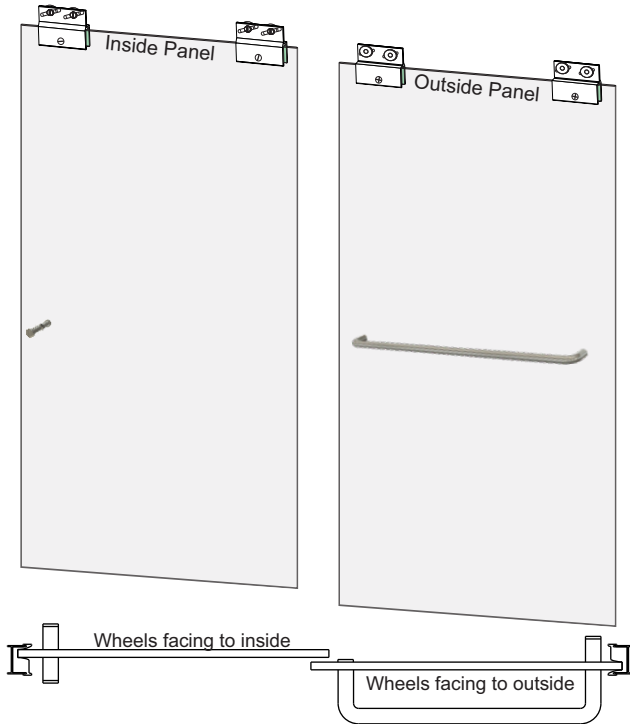

## Shower Head Right

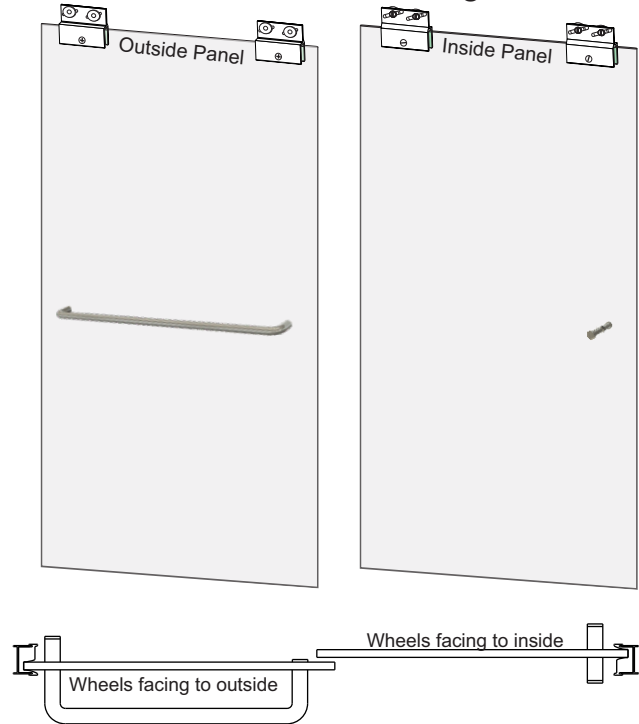
**Installing the hanger brackets:**

**STEP 1** - Match the shower head location of your shower (left or right) to the corresponding diagrams above

**STEP 2** - Orient your panels to as shown on the selected diagram and place the rollers on the glass being careful to orient the roller facing inside or outside as shown

**STEP 3** - Align the hole in the bracket to the hole in the glass and Insert the nylon fastener as shown below (opposite the side of the rollers)

**STEP 4** - Insert and tighten the flathead screw into the nylon fastener

**NOTE:** If hanger brackets are already assembled to the glass, check to ensure they are correctly oriented according to the proper diagram above. If there is an error, remove the brackets that are improperly oriented (probably on the knob panel), rotate them 180° and follow STEP 3 and STEP 4 above to properly re-secure them to the panel(s).

**Fastening the hanger brackets:**